

Washlet EK TCF6402G/GE

washlet®

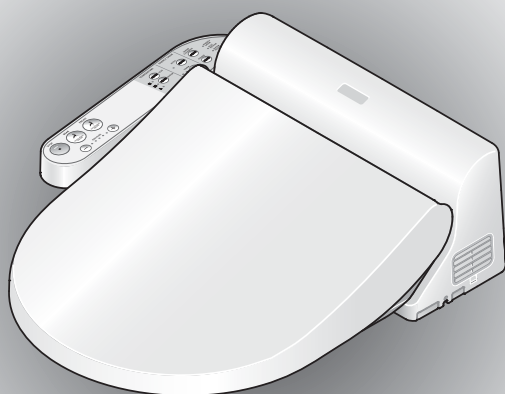

Cautions and warnings	2	Introduction
Precautions for use	6	
Efficient use	7	
Overview of features	8	
Initial settings list	8	
Names of parts	9	
Before use	10	

How to use the Washlet	12	Operation
Convenient functions	14	
• Adjusting the temperature	14	
Energy saver functions	16	
• Smart Energy Saver	17	
• Timer-based Energy Saver	17	

Maintenance	20	Cleaning
• Before cleaning	20	
• Daily cleaning	21	
• Cleaning the main Washlet unit, seat and lid	21	
• Thorough cleaning	22	
• Cleaning the clearance between the seat and lid	22	
• Cleaning the clearance between the main Washlet unit and the toilet	23	
• Periodic cleaning	24	
• Cleaning the mains plug	24	
• Cleaning the wand	24	
• Cleaning the drain valve with filter	25	

Preventing damage from freezing and measures for long-term disuse	27	Troubleshooting
Troubleshooting	32	
Specifications	37	

Warranty	38
---------------------------	-----------

Important User Guidance Information	39
--	-----------

- Thank you very much for purchasing this Washlet. Please read this instruction manual carefully to ensure proper use.
- The specifications, model number, etc. are subject to change without prior notice.
- “Washlet” is a registered trademark of TOTO.

Cautions and warnings

Always observe these warnings.

Please read these cautions and warnings carefully and use the equipment correctly.





Follow all safety precautions and warnings.

- The meanings of these indications are as follows.



	WARNING	This mark indicates that misoperation and improper handling may result in death or serious injury.
---	----------------	--

	CAUTION	This mark indicates that misoperation may result in injury or physical damage.
---	----------------	--

- The following symbols are used to classify and explain instructions that must be followed.

Symbol example	Meaning of symbol
	The  symbol indicates something that is prohibited.
	The  symbol indicates information of great importance.

- This product is classified as Class 1 Equipment and must be earthed via an earth connection.
- Install this equipment close to a mains socket.
- This equipment is not to be used by any person who has reduced physical, sensory or mental abilities (including children), nor is it to be used by any person who lacks sufficient experience or knowledge. However, such persons may use the equipment when a person who takes responsibility for their safety provides supervision and direction. Children must be supervised to make certain that they do not play with the equipment.
- Use the new hose set included with this equipment. Do not reuse an old hose set.

	
	<p>For Continental Europe</p> <p>Do not wet the main Washlet unit or mains plug with water or cleaning fluid.</p> <ul style="list-style-type: none"> Doing so could cause fire or electric shock. <p>For United Kingdom</p> <p>Do not wet the main Washlet unit or electrical box with water or cleaning fluid.</p> <ul style="list-style-type: none"> Doing so could cause fire or electric shock.
	<p>Since this is electronic equipment, do not locate it anywhere it might be splashed or otherwise wet. Likewise, do not locate it in a humid place where water could drip onto the surface of the Washlet. When using it in a bathroom, install a ventilation fan or ventilation opening, so that the bathroom has sufficient airflow.</p> <p>Install the Washlet at least 0.60 m away from any bathtub.</p> <ul style="list-style-type: none"> Failure to observe this caution may result in fire or electrical shock. <p>Prepare the socket for the electrical wiring as follows.</p> <ul style="list-style-type: none"> Failure to observe this caution may result in fire or electrical shock. <ol style="list-style-type: none"> Provide electric current to the socket (device) using a differential residual electric current device (DDR) with a released current that does not exceed 30 mA. Locate the socket (device) and its wiring plug at least 0.60 m from the outside edge of a shower chamber or bathtub. * Confirm that the wiring for items a and b above has been completed. If the wiring has not been completed, request completion from the business that installed the unit.

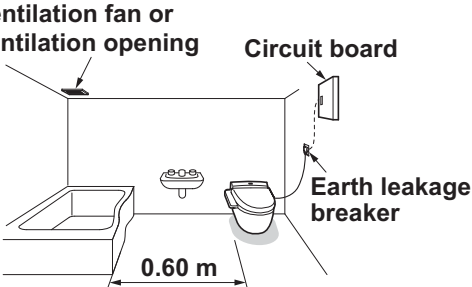

Ventilation fan or ventilation opening Circuit board

Earth leakage breaker

0.60 m

⚠ WARNING

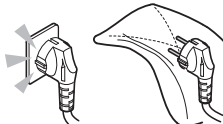
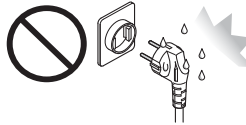
	<p>Confirm that the earth wire has been installed properly.</p> <ul style="list-style-type: none"> • If an earth wire is not installed, electric shocks could occur in the event of a malfunction or a short-circuit. Note: Use copper wire with a diameter of 1.6 mm or more and with an earth resistance of 100 Ω or less. * If an earth wire has not been installed, request installation from the business that installed the unit. <p>For Continental Europe</p> <p>Always insert the electrical cord completely into the socket (220 - 240 V AC, 50 Hz).</p> <p>For United Kingdom</p> <p>Confirm that the electrical cord is connected.</p> <ul style="list-style-type: none"> • Failure to observe this caution may result in fire or electrical shock. * Follow the installation requirements for the country in which the Washlet is being installed. <p>Always connect the Washlet to the cold water supply.</p> <ul style="list-style-type: none"> • Failure to do so could cause burns or malfunction of the equipment.
<p style="text-align: center;">! Required</p>	<p>Be careful to prevent low-temperature burns.</p> <ul style="list-style-type: none"> • When seated on the Washlet for a long time, set the seat temperature to adjustment button in the off position. • Another person should set the seat temperature adjustment button in the off position before following types of people use the Washlet. <ul style="list-style-type: none"> • Children, elderly and other people who cannot adjust the temperature suitably themselves. • Sick or physically disabled people and others who might not be able to move freely. • People who have taken medication that causes drowsiness (sleep aids, cold medicine, etc.), people who have drunk much alcohol, extremely fatigued people and others who might fall asleep unintentionally.
	<p>Only for Continental Europe</p> <p>Remove dust that has adhered to the mains plug blades or other parts regularly and insert it into the socket completely.</p> <ul style="list-style-type: none"> • Dust could cause fire or electrical shock. If dusty, disconnect the plug and wipe it with a dry cloth. 
	<p>Only for Continental Europe</p> <p>When removing the mains plug, always hold and pull the plug itself.</p> <ul style="list-style-type: none"> • If you pull on the cord, the plug and cord could be damaged, and fire or electrical shock could result. <p>To reduce the danger of burns, death from electric shock, fire or other human injury:</p> <ul style="list-style-type: none"> - Close supervision is necessary when this product is used by or near children or invalids. - Use this product only for its intended use as described in this manual. Do not use accessories not recommended by the manufacturer. - Keep the cord away from heated surfaces. - Connect this product to a properly earthed socket only. See the Earthing Instructions. - The tank should only be filled with water.
<p style="text-align: center;">⊘ Do not disassemble</p>	<p>Never disassemble, repair or modify the equipment.</p> <ul style="list-style-type: none"> • This could cause fire or electric shock.
<p style="text-align: center;">⊘ Do not touch with wet hands</p>	<p>For Continental Europe</p> <p>Do not remove the mains plug with wet hands.</p> <ul style="list-style-type: none"> • This could cause electric shock. <p>For United Kingdom</p> <p>Do not touch the connection part of the electrical box with wet hands.</p> <ul style="list-style-type: none"> • This could cause electric shock. 

WARNING

Do not install the Washlet on moving bodies such as vehicles, boats and vessels.

- Otherwise, fire, electric shock or trouble may be caused.
- The main unit may dislodge and fall whereby causing injury.

Do not continue to use the Washlet if broken or malfunctioning.

- In the following situations, disconnect the mains plug and close the water stop valve to stop the water supply.

Possible malfunctions

- Water is leaking from plumbing or the main unit.
- The Washlet has a crack or a break in it.
- The Washlet is making strange sounds or emitting strange odors.
- Smoke is coming from the Washlet.
- The Washlet is unusually hot.

- Continued use of a malfunctioning or broken unit could cause fire, electric shock, or flooding of the room containing the unit.

Do not do anything that could damage the power cord or seat cord.

Do not pull, twist, excessively bend, intentionally damage, alter or heat the cords. Do not put heavy items on the cords.

- Continued use of a unit with a damaged cord could cause fire, electric shock, or a short circuit.



Prohibited

Only for Continental Europe

Do not use a loose mains socket.

- This could cause fire or electric shock.

Do not use this product with any power supply other than the specified (220 - 240 V AC, 50 Hz).

- Failure to observe this caution may result in fire or electrical shock.

Do not use sockets or wiring equipment exceeding the rated values.

- Use of multi-prong mains adapters and other actions that exceed the rated values could cause fire from excess heat.

Use only tap water or potable well water (groundwater).

- Use of other water could cause skin inflammation or other problems.

To reduce the danger of burns, death from electric shock, fire or other human injury:

- Never operate this product if it has a damaged cord or plug, if it is not working properly, if it has been dropped or damaged, or if it has been dropped in water. Return the product to TOTO Europe GmbH for examination and repair.
- Never block the air openings of the product or place it on a soft surface, such as a bed or a couch, where the air openings could be blocked. Keep the air openings free of lint, hair or a similar material.
- Never use it while sleepy or drowsy.
- Never drop or insert anything into any opening or hose.
- Do not use it outdoors where aerosol (spray) products are being used or where oxygen is being administered.

For Continental Europe

Always disconnect the mains plug from the socket when cleaning.



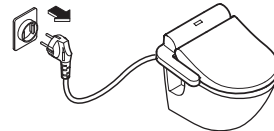

For United Kingdom

Always turn off the breaker on the distribution board when cleaning.

- Failure to do so could cause electric shock.
- * Use of the "Wand cleaning" button is an exception to this rule.

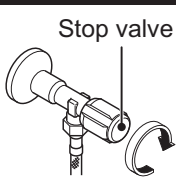
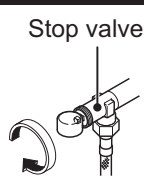
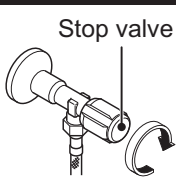
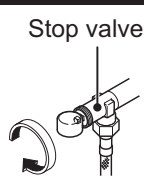
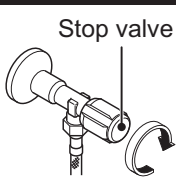
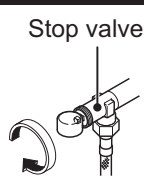

⚠ CAUTION

 Flammable	<p>Do not bring lit cigarettes or other burning materials near the Washlet.</p> <ul style="list-style-type: none"> • Doing so could cause fire. 		
 Prohibited	<p>When cleaning plastic parts, including the main Washlet unit, use diluted (pH-neutral) kitchen cleaning detergent. Do not use the following: Toilet cleaners, household cleaners, benzine (naphtha), paint thinner, cleanser, nylon scrubbing pads, etc.</p> <ul style="list-style-type: none"> • These could damage the plastic or cause cracks, which could lead to injury. • These could damage the water supply hose, resulting in water leaks. 		
	<p>Do not subject the main Washlet unit to strong force or sudden shock. Do not climb on the seat, the lid or any other part of the main Washlet unit. Do not put heavy objects on it.</p> <ul style="list-style-type: none"> • Injury could result if the main Washlet unit breaks or becomes dislodged and falls. 		
	<p>Do not lift the Washlet by the seat or lid.</p> <ul style="list-style-type: none"> • Injury could result if the main Washlet unit becomes dislodged and falls. 		
	<p>Do not detach the drain valve with filter while the water stop valve is still open.</p> <ul style="list-style-type: none"> • Doing so will cause water to spill. <p style="text-align: right;">▶ See “Cleaning the drain valve with filter” on page 25.</p>		
	<p>Do not bend or crush the water supply hose.</p> <ul style="list-style-type: none"> • This could cause a water leak. 		
	<p>To reduce the danger of death from electric shock:</p> <ul style="list-style-type: none"> - Do not use while bathing. - Do not place or store the product where it could fall or be pulled into a tub or sink. - Do not put in or drop into water or other liquid. - Do not try to recover the product if it has fallen into water. Unplug it immediately. 		
 Required	<p>For Continental Europe</p> <p>If the Washlet will not be used for a long time, close the water stop valve, drain the water and disconnect the mains plug.</p> <p style="text-align: right;">▶ See “Draining the water” on page 29.</p> <ul style="list-style-type: none"> • For safety, disconnect the mains plug. • Run water through the Washlet before using it again because water left in the unit may have spoiled and could cause skin inflammation or other problems. <p style="text-align: right;">▶ See “Restoring the water supply after draining the Washlet” on page 31.</p>		
	<p>For United Kingdom</p> <p>If the Washlet will not be used for a long time, close the stop valve, drain the water and turn off the breaker on the distribution board.</p> <p style="text-align: right;">▶ See “Draining the water” on page 29.</p> <ul style="list-style-type: none"> • For safety, turn off the breaker on the distribution board. • Run water through the Washlet before using it again because water left in the unit may have spoiled and could cause skin inflammation or other problems. <p style="text-align: right;">▶ See “Restoring the water supply after draining the Washlet” on page 31.</p>		
	<p>If a water leak occurs, close the water stop valve and stop the water supply.</p> <table border="1" style="width: 100%; border-collapse: collapse;"> <tr> <td style="width: 50%; text-align: center;"> <p>For wall-mounted toilet</p>  <p>Stop valve</p> <p>Turn clockwise.</p> </td> <td style="width: 50%; text-align: center;"> <p>For floor-mounted toilet</p>  <p>Stop valve</p> <p>Turn clockwise.</p> </td> </tr> </table>	<p>For wall-mounted toilet</p>  <p>Stop valve</p> <p>Turn clockwise.</p>	<p>For floor-mounted toilet</p>  <p>Stop valve</p> <p>Turn clockwise.</p>
	<p>For wall-mounted toilet</p>  <p>Stop valve</p> <p>Turn clockwise.</p>	<p>For floor-mounted toilet</p>  <p>Stop valve</p> <p>Turn clockwise.</p>	
<p>Thoroughly tighten the drain valve with filter.</p> <ul style="list-style-type: none"> • Failure to do so could cause a water leak. 			
<p>Prevent damage from freezing.</p> <ul style="list-style-type: none"> • Freezing could cause damage to the water supply plumbing and the inside of the Washlet, resulting in a leak. • Use a heater or other means to keep the toilet warm. <p style="text-align: right;">▶ See “Preparation for freezing conditions” on page 27.</p>			

CAUTION



Required

Push the main unit securely to the base plate.

- After pushing the main unit until a click sound is heard, pull it slightly toward you to make sure that the product does not detach.
- Otherwise, the main unit may detach and fall, resulting in injury.

Earthing Instructions

For Continental Europe

This product must be earthed. If an electrical short circuit occurs, earthing reduces the risk of electric shock by providing an escape wire for the electrical current. This product is equipped with a cord that has an earth wire and an earthing plug. The plug must be plugged into a socket that is properly installed and earthed.

Improper use of the earthing plug can result in the risk of an electric shock.

If the cord or plug requires repair or replacement, do not connect the earthing wire to either of the flat blade terminals. The earth wire has insulation that is green on the outside and might or might not have yellow stripes. Check with a qualified electrician or serviceman if you do not completely understand the earthing wire instructions or have a doubt about whether the product is properly earthed.

This product is equipped at the factory with a specific electrical cord and plug that allow connection to a suitable electrical circuit. Confirm that the product is connected to a socket with the same configuration as the plug. Do not use an adapter with this product. Do not modify the included plug. If the plug and socket are not compatible, have a suitable socket installed by a qualified electrician. If the product must be reconnected for use with a different type of electrical circuit, qualified service personnel must conduct the reconnection.

If it is necessary to use an extension cord, use only a three-wire extension cord that has a three-blade earthing plug and a three-slot socket that accepts the plug on the product cord. Replace or repair a damaged cord.

For United Kingdom

Confirm that the earthing wire is securely connected.

Save these instructions.

Precautions for use

Please follow these instructions regarding the Washlet.

Do not wipe the main Washlet unit, seat or lid with dry cloth, toilet paper or similar materials.

▶ See "Maintenance" on page 20.

Do not expose to direct sunlight.

- Direct exposure could cause changes in colour, irregular temperature in the heated seat or malfunction.

Avoid urinating on the main Washlet unit and wand.



Do not lean against the lid.



For Continental Europe
Disconnect the mains plug during thunderstorms.

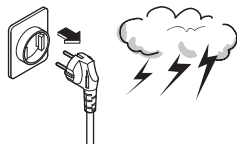

For United Kingdom
Turn off the breaker on the distribution board during thunderstorm.

Use radios and similar devices at a distance from the Washlet.

- The Washlet could cause interference to the radio signal.

Efficient use

Save energy to protect the global environment.

Using the timer-based Energy Saver.

Once set, the seat heater and the warm water heater are turned off automatically everyday at the set time to save energy. The duration of the Energy Saver can be set to 6 or 9 hours. ▶ See page 17.

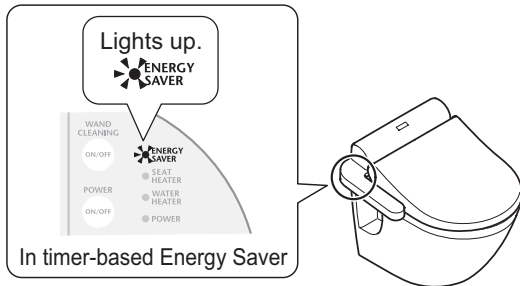

Close the lid.

By closing the lid, less warmth escapes from the seat surface, thus conserving energy.

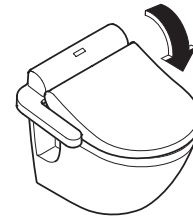

Set the temperature lower.

To conserve energy set the temperature just high enough so that the seat does not feel cold. ▶ See page 14.

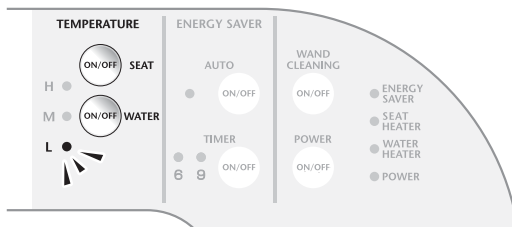

Set the Operation ON/OFF button to "OFF" when the Washlet will not be used for a long time.

When leaving the house for example, set the button to "OFF" to conserve energy. ▶ See page 11.

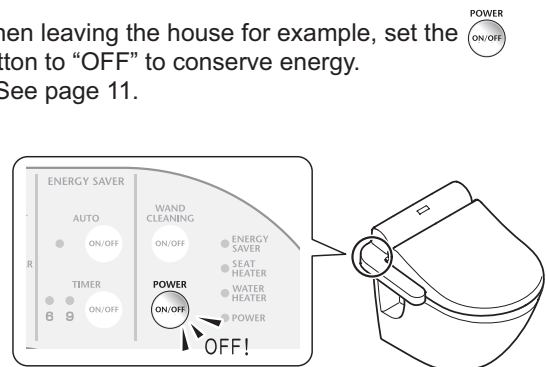

About the seating switch

- When you sit on the seat, the seating switch turns on, enabling you to use various functions.

* The seating switch may not turn on unless you sit on the seat fully, as seen in the diagram below. (When a lightweight child uses the Washlet, the seating switch may be difficult to turn on.)

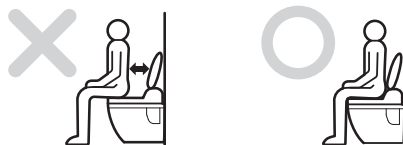

- A click sound is heard when the seating switch turns on.
- Since the seat is designed to move up and down, a clearance is provided between the seat cushion and the toilet.

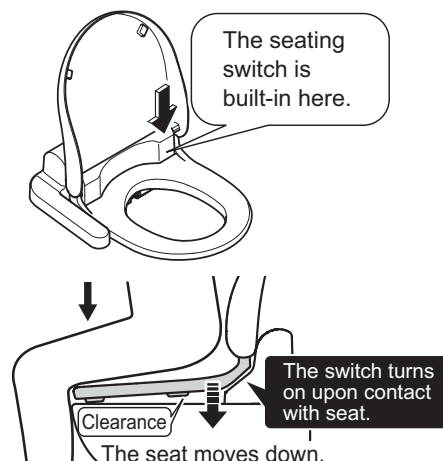

Overview of features

Washlet functions		Page
Rear wash	• Washes the rear.	12
Front wash	• Use as a bidet for women.	12
Water pressure adjustment	• Adjusts the water pressure.	12
Oscillating wash	• Moves the wand forward and backward for thorough cleaning over a wide area.	12

Convenient features		Page
Heated seat	• Warms the seat.	-
Temperature adjustment	• Adjusts the temperature of the water and the seat.	14
Seat sensor (Seating switch)	• Activates various functions when a person sits on the seat.	7
Soft closing	• Closes the seat and lid slowly.	-

Energy saver functions		Page
Timer-based Energy Saver	• Once set, the seat heater and the warm water heater will turn off at the set time every day to save energy. (The Energy Saver time can be set to either 6 hours or 9 hours.)	16, 17
Smart Energy Saver	• The Washlet memorizes the time slot where the toilet is used less frequently and lowers the seat temperature automatically to save energy.	16, 17
Power ON/OFF button	• By turning this button "OFF", the operation of the heated seat and other functions can be stopped for thorough energy conservation.	11

Cleaning features		Page
Removable lid	• The lid can be removed easily for easy cleaning accessibility.	22
One-touch attachment and removal of the main Washlet unit	• The main Washlet unit can be removed by simple operation, allowing easy access to the back of the toilet for cleaning.	23
Self-cleaning	• The wand tip is automatically cleaned thoroughly before and after washing.	-
Thorough wand cleaning	• The wand body is automatically cleaned thoroughly during the retracting and extending movements.	-
Wand cleaning	• The wand can be extended without emitting water for easy cleaning accessibility.	24

Initial settings list

Functions	Initial Settings		Page
Warm water temperature	M (medium)	<p>TEMPERATURE</p> <p>The temperatures can be adjusted with these buttons.</p>	14, 15
Seat temperature	H (high)		14, 15
Smart Energy Saver	OFF	• The Smart Energy Saver function can be set to "ON" or "OFF".	16, 17
Timer-based Energy Saver	OFF	• The Timer-based Energy Saver function can be set to "ON" or "OFF".	16, 17
		• The Energy Saver time span can be changed.	18

Names of parts

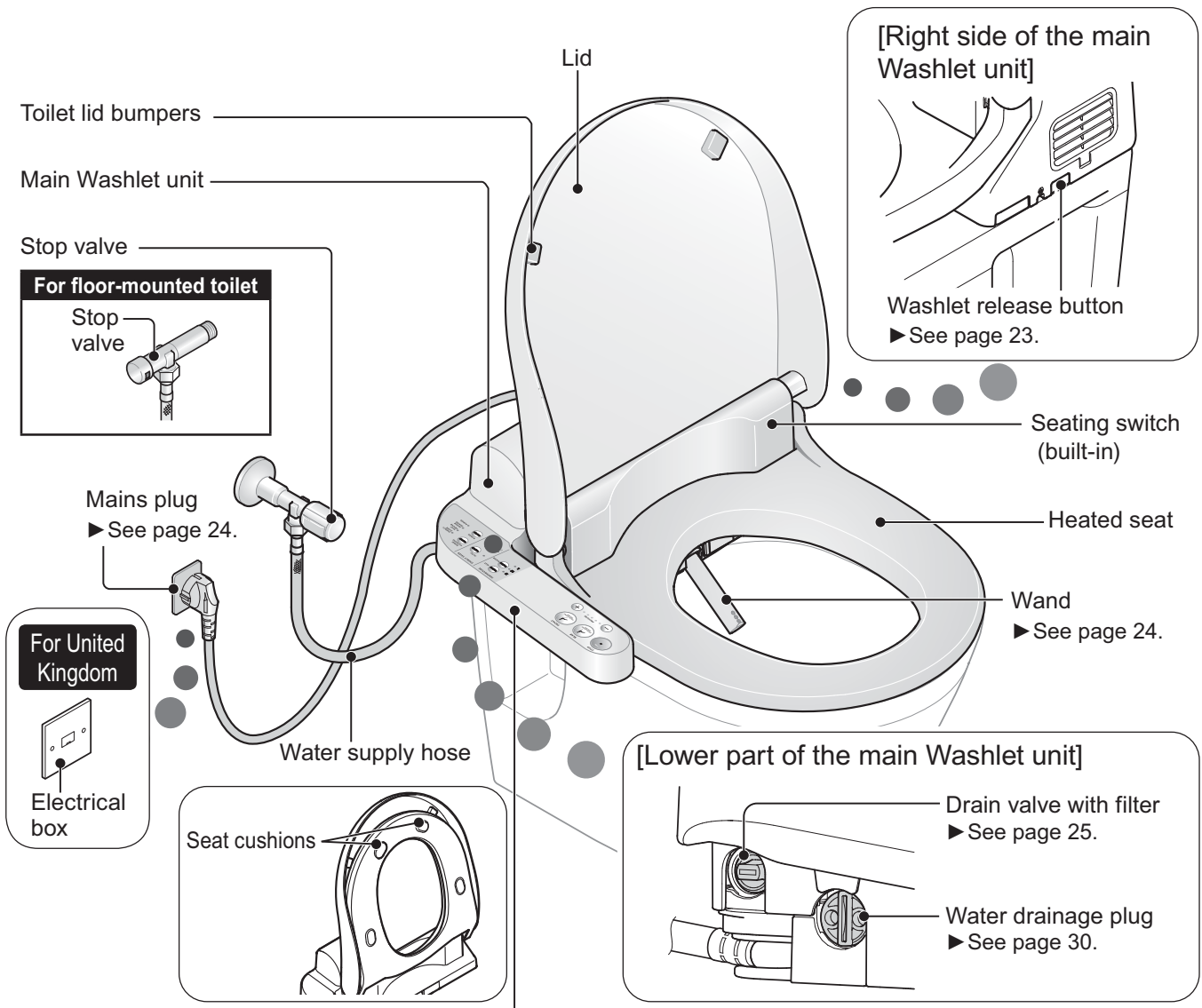

Washlet main operation unit

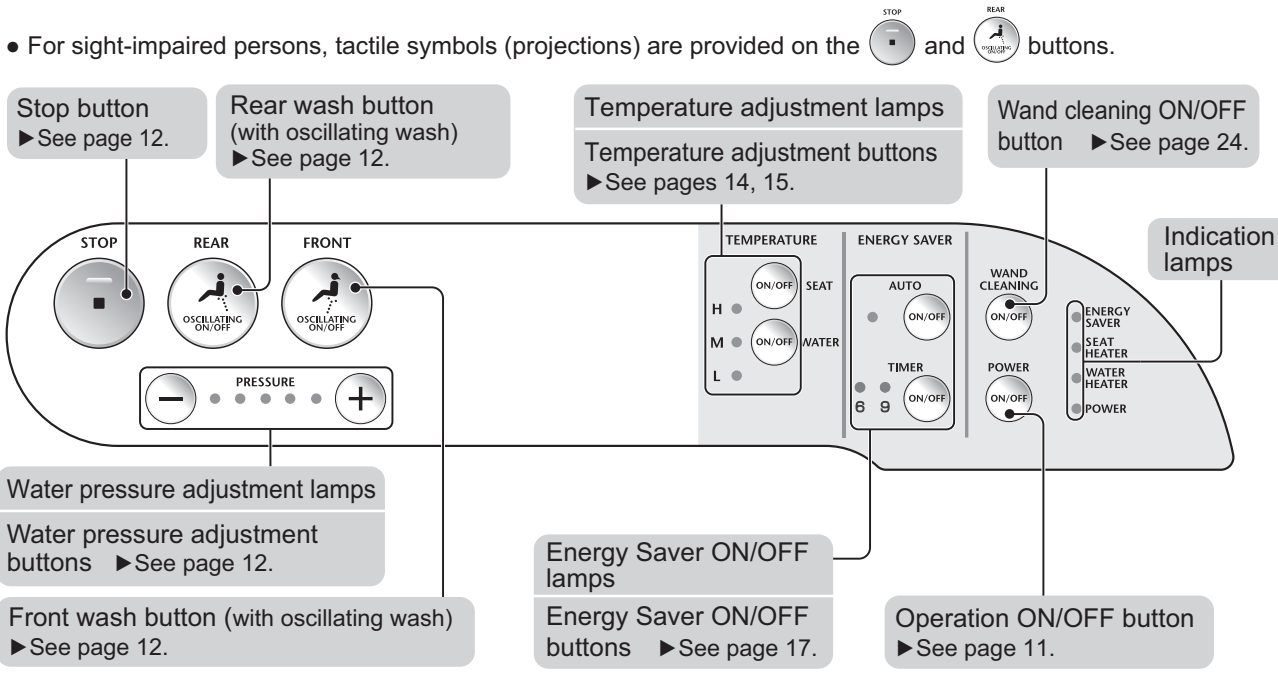

Before use

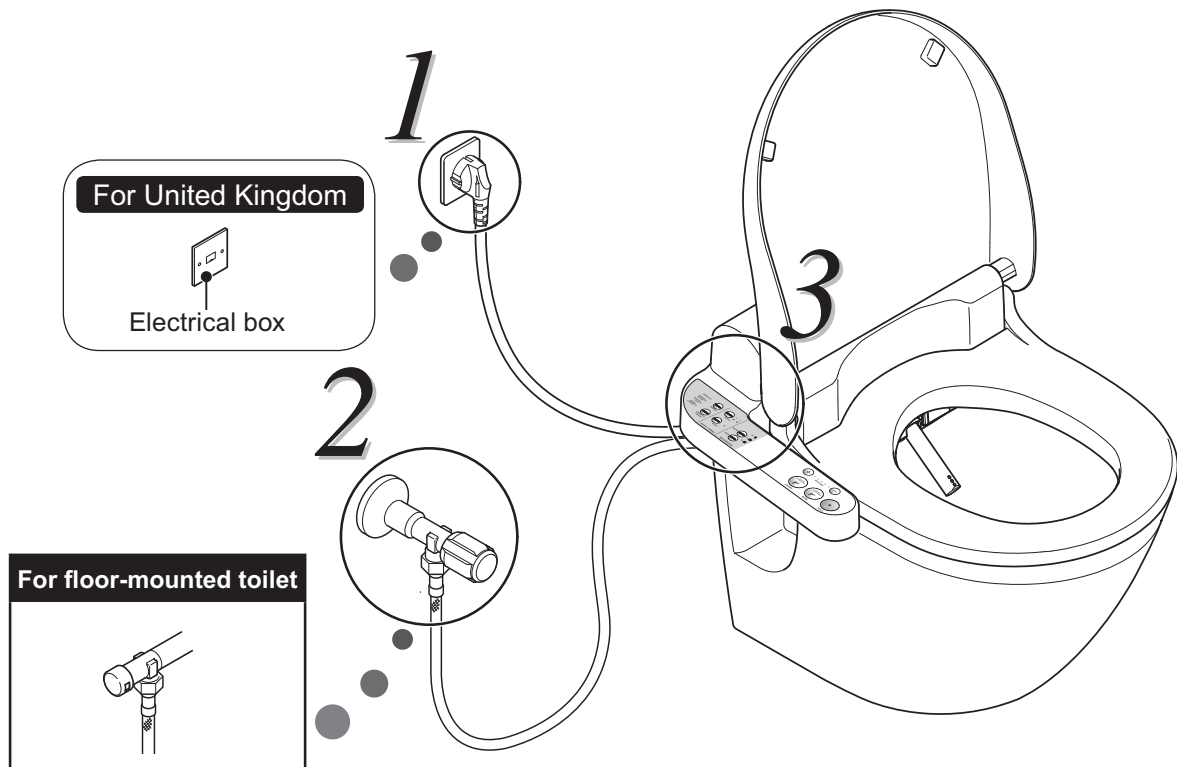

Preparation

1 **Only for Continental Europe**
Insert the mains plug into the socket.

- The POWER lamp will light up automatically.

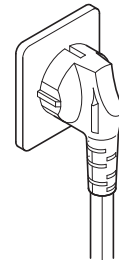

2 Open the stop valve.

For wall-mounted toilet

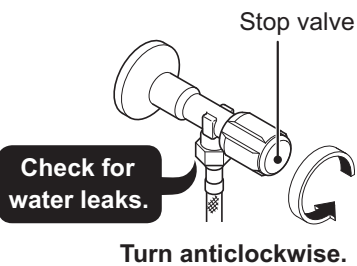

For floor-mounted toilet

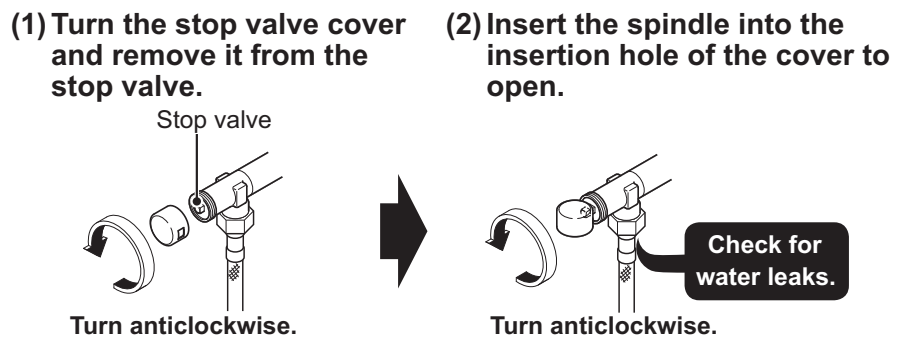

Confirm

3 Check the lamps on the Washlet main operation unit.

- Is the POWER lamp on the Washlet main operation unit lit?

If the POWER lamp is not lit, none of the functions can be used.

(Except when the Energy Saver is in use. ► See page 19.)

Press the  button on the Washlet main operation unit.
(The POWER lamp will light up.)

Turning off the power

Press  to turn off the power.

- The POWER lamp will go off.

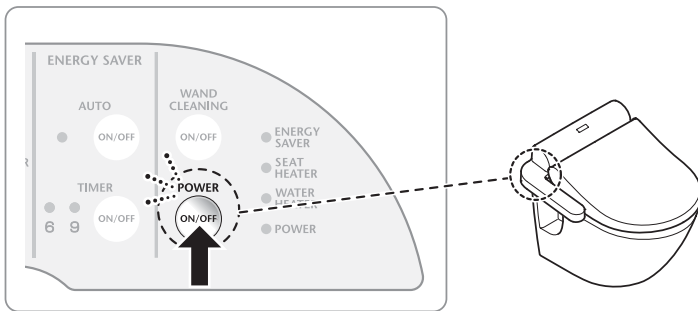

Washlet main display

- ENERGY SAVER
- SEAT HEATER
- WATER HEATER

 POWER
POWER lamp

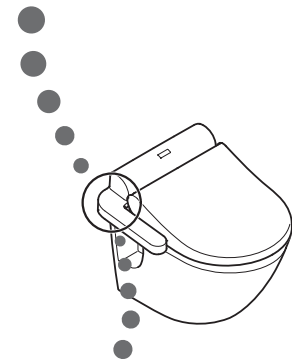

Washlet main operation unit

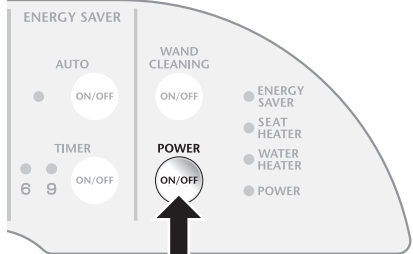

How to use the Washlet

Standard use of the Washlet

1 Sit on the seat.

- The seating switch detects the presence of a person and all the functions become operative.
 - ▶ See “About the seating switch” on page 7.

2 Use and stop the washing functions.

Tip 1

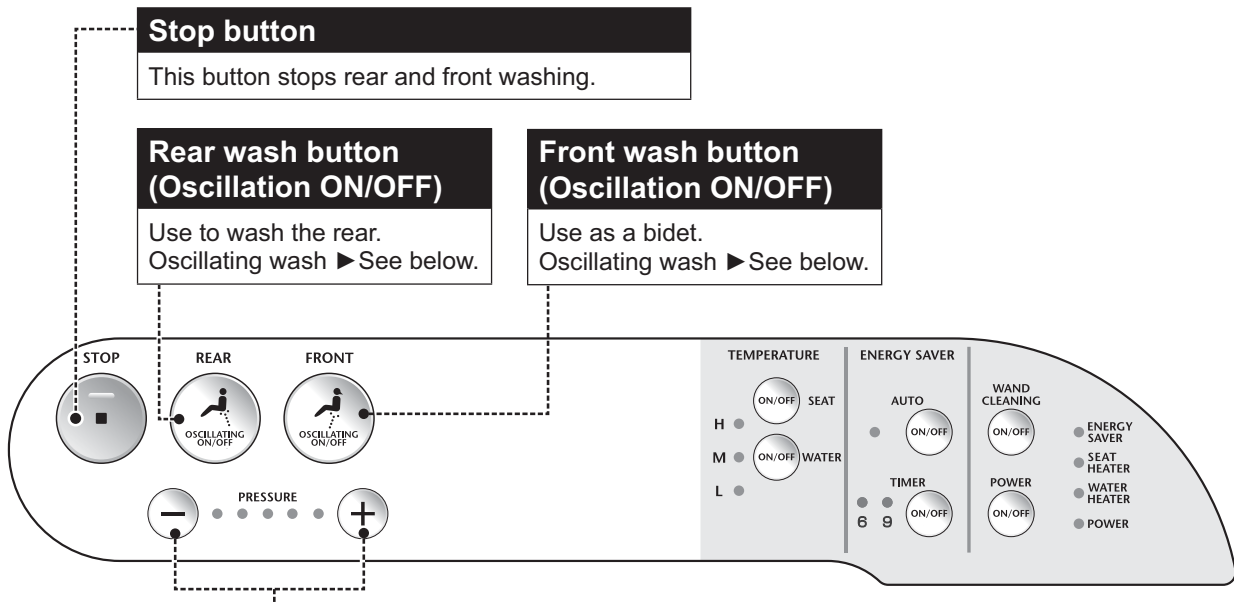

Water pressure adjustment buttons

The water pressure can be adjusted as desired in 5 levels.
 * The water pressure adjustment lamp lights up when you sit on the toilet seat.

Indication of the water pressure adjustment lamp

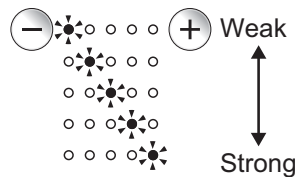

Other convenient functions

Oscillating wash

This function moves the wand backward and forward to wash thoroughly over a larger area.

(1) Press the  or  button to select.

- (2) Press the same button once.
- This starts the oscillating wash.
- (3) Press the same button again.
- This stops the oscillating wash.

Tip 1

Please sit fully on the seat.

- The seating switch may not be activated if you do not sit back.
- By sitting in the correct position, you will be able to maintain accurate washing position. This will also prevent water from spraying out of the toilet.

3 Stand up from the seat.

- Water is sprayed from around the wand into the toilet for a few seconds.
- * **Water remaining in the wand is discharged from around the wand into the toilet.**

Please be aware of the following points

- When the Washlet is in use or the wand cleaning is in use, water comes out of the right side of the wand. This is necessary for proper functioning and is perfectly normal.
- * If water continues to come out when the Washlet is not being used for washing, there may be a malfunction. Close the stop valve, and contact the installer or seller of this Washlet.
- Water in the warm water tank expands and is sometimes discharged from the around of the wand.

Convenient functions

Adjusting the temperature

- The warm water and seat temperatures can be adjusted with the temperature adjustment buttons on the Washlet main operation unit. Please set them to the temperatures you prefer.

Adjusting water temperature and seat temperature

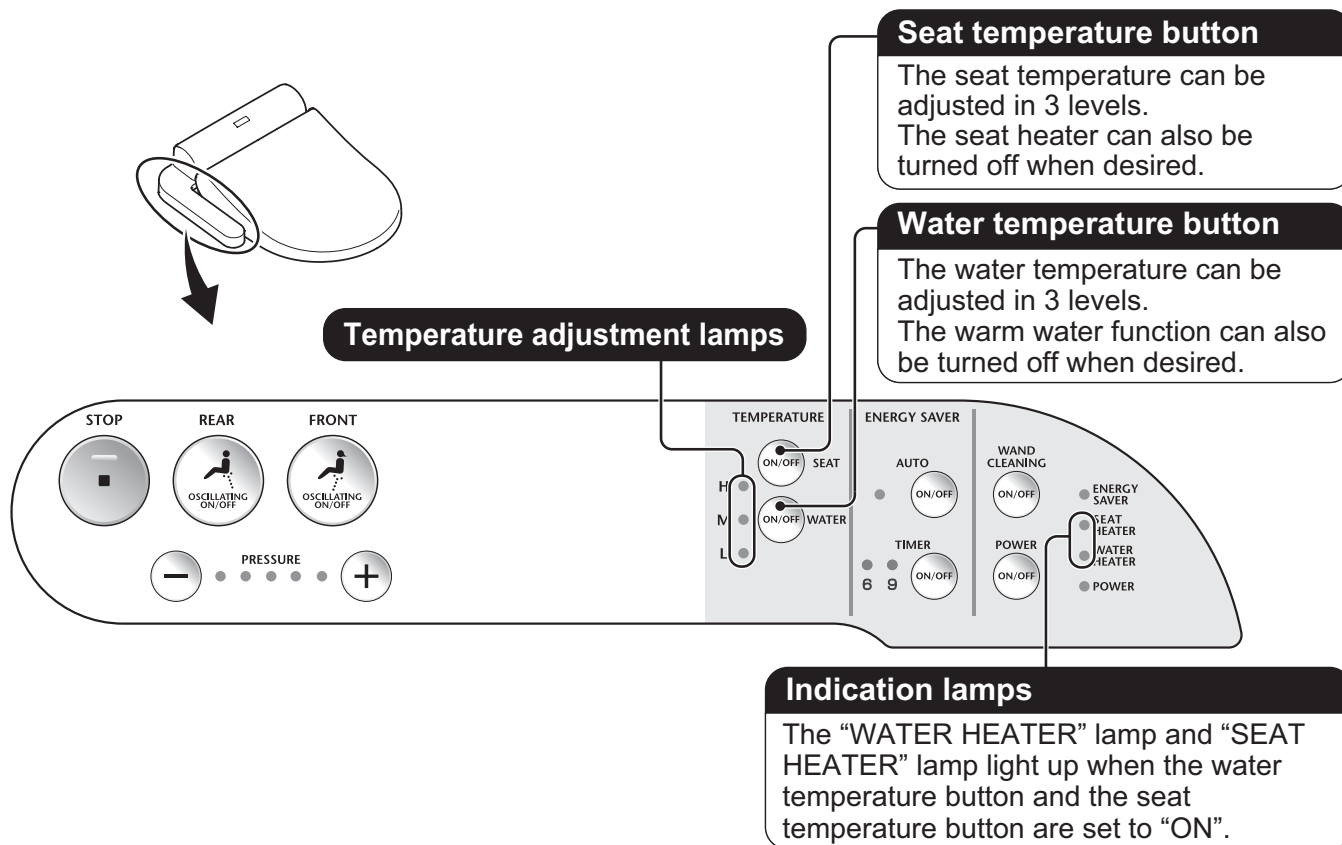

1 Press the temperature adjustment button on the Washlet main operation unit.

- Press either **ON/OFF SEAT** or **ON/OFF WATER** button to change the temperature.

The temperature adjustment lamp indicates the current temperature level.

Tip 1

[Example: To change the seat temperature]

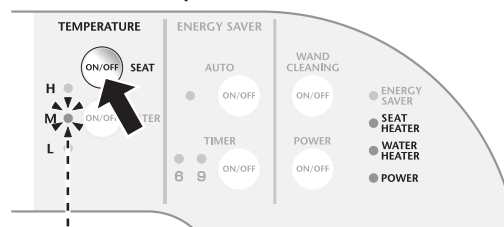

Lights up.

The temperature adjustment lamps are shared to indicate the warm water temperature and the seat temperature.

Tip 1

The temperature level is indicated for the pressed button only, which is either the seat temperature button or water temperature button.

2 Press the temperature adjustment button repeatedly until the temperature reaches the desired level.

Each time you press the temperature adjustment button, the temperature adjustment lamp is switched.

Tip  2

The setting is complete.

[The temperature level is switched as below.]

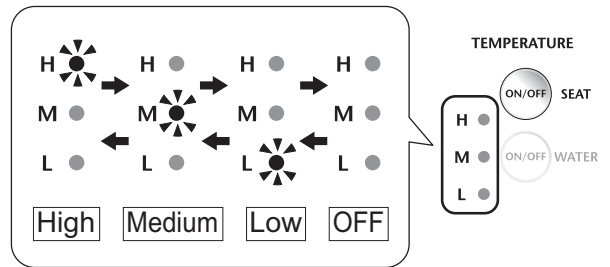

Setting the water heater and seat heater to “OFF”

1 Press the temperature adjustment button on the Washlet main operation unit.

- Press either  SEAT or  WATER button to make the setting to “OFF”.

The temperature adjustment lamp indicates the current temperature level.

[Example: To turn “OFF” the toilet seat heater]

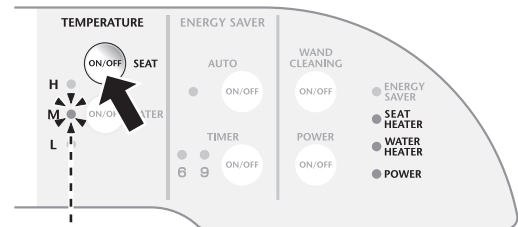



Lights up.

2 Press the temperature adjustment button repeatedly until the temperature adjustment lamp goes out.

Tip  3

The setting is complete.

- To set the heaters to “ON” again, press either  SEAT or  WATER button to make the setting to “ON” and light up the temperature adjustment lamp.

Tip  4

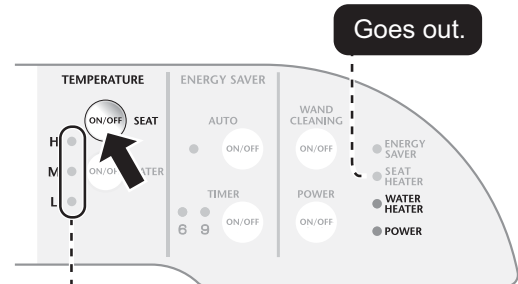

Goes out.

Tip  2

The temperature adjustment lamp goes out when you release your finger from the temperature adjustment button for about 10 seconds. If the lamp goes out during temperature adjustment, press the button again and set the temperature to the desired level.

Tip  3

When the temperature adjustment lamp goes out, the indication lamps goes out at the same time.

Tip  4

When the temperature adjustment lamp lights up, the indication lamps of the current temperature setting lights up at the same time.

Energy saver functions

Automatic Energy Saving performed by the Washlet.*

This feature prevents unnecessary electric energy from being consumed while sleeping at night or in the early morning

Smart Energy Saver

The Washlet memorizes when the toilet is used and when the toilet is used less frequently and lowers the toilet seat temperature (26°C) automatically in that time slot to save energy.

Example When the toilet is used less frequently from 21:00 to 6:00.

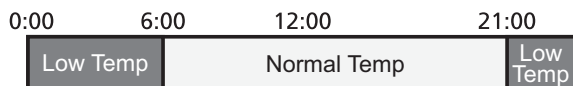

► See "Setting the Smart Energy Saver" on page 17.

Manual Energy Saving using the timer function.

User stays away from home for work everyday during a specific time slot

Timer-based Energy Saver

Once set, the seat heater and the warm water heater are turned off automatically everyday at the set time to save energy. The energy saver time can be set to either 6 hours or 9 hours.

Example When the toilet is not used from 8:00 to 17:00.



► See "Setting the Timer-based Energy Saver" on page 17.

The Smart Energy Saver and the Timer-based Energy Saver can be used at the same time.

Timer-based Energy Saver + Smart Energy Saver

When the Timer-based Energy Saver mode is not in operation, the Smart Energy Saver mode functions to save energy.

Example Combination of the Timer-based Energy Saver and the Smart Energy Saver modes.

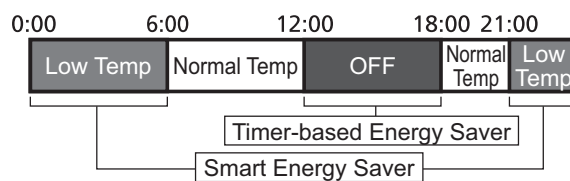

► See "Setting the Smart Energy Saver", "Setting the Timer-based Energy Saver" on pages 17, 18.

The Washlet can be used even while the Energy Saver is set. (The seat is heated temporarily when you sit on the seat.)
 * It takes about 10 days to find the time slot where the toilet is used less frequently.

Saving energy automatically Smart Energy Saver

Setting the Smart Energy Saver

1 Press the button.

- The lamp indication is switched each time this button is pressed.

To set the Smart Energy Saver to "OFF"

Press the button repeatedly until the Smart Energy Saver ON/OFF lamp goes out.

The setting is complete.

To set the Smart Energy Saver to "ON"

Press the button repeatedly until the Smart Energy Saver ON/OFF lamp lights up.

The setting is complete.

- Energy is saved by lowering the seat temperature automatically. The Energy Saver indication lamp lights up during the time slot in which the toilet is used less frequently is reached.

Tip  1

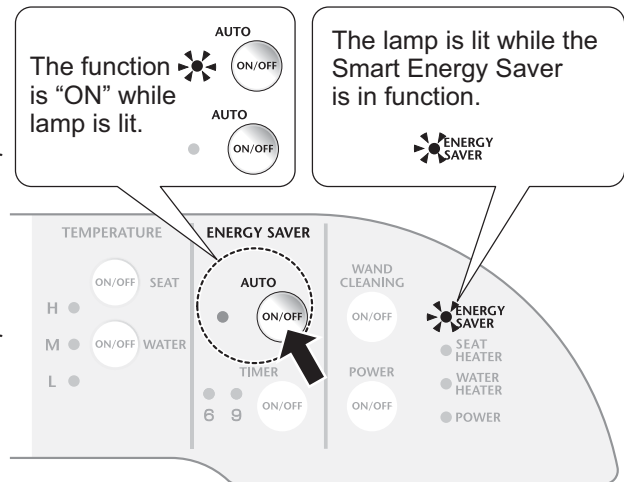

Saving energy by designating a time slot Timer-based Energy Saver

Setting the Timer-based Energy Saver

Example) When energy is saved from 1:00 to 7:00 (for 6 hours)

1 When the time (1:00) you want to start saving energy is reached, press the button repeatedly until the "6" lamp lights up.

- The lamp indication is switched each time this button is pressed.

- The Energy Saver indication lamp lights up.

The setting is complete.

Tip  2

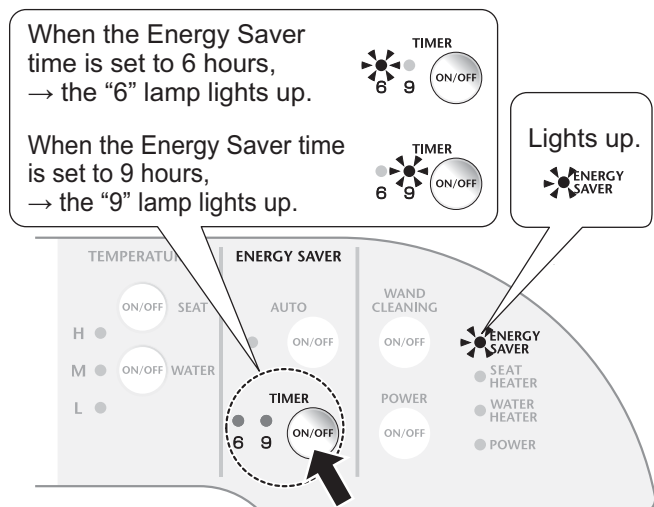

Tip  1

- It takes about 10 days to find the time slot where the toilet is used less frequently.
- When you sit on the seat (the seating switch is on), the Energy Saver indication lamp goes out.

Tip  2

- When you sit on the seat (the seating switch is on), the Energy Saver indication lamp goes out.

Changing the Energy Saver time

The Energy Saver time can be changed to either 6 hours or 9 hours.

1 Press the button.

- The lamp indication switches each time this button is pressed. Press the button repeatedly until the lamp of the time you want to set lights up.

* To change the Energy Saver time (6 hours or 9 hours), set the timer again at the time when you want to start saving energy.

Tip  1

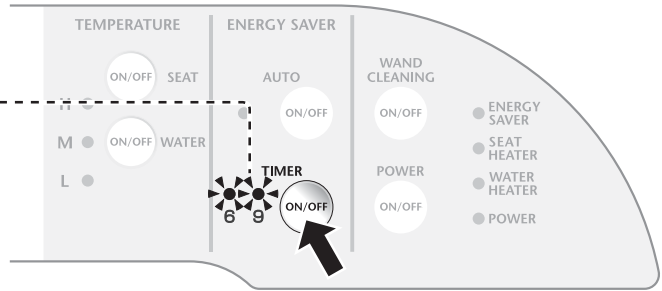

When not using the Timer-based Energy Saver

1 Press the button repeatedly until the Timer-based Energy Saver lamp goes out.

The setting is cancelled.

- The POWER lamp, WATER HEATER lamp and SEAT HEATER lamp on the Washlet main operation unit light up.

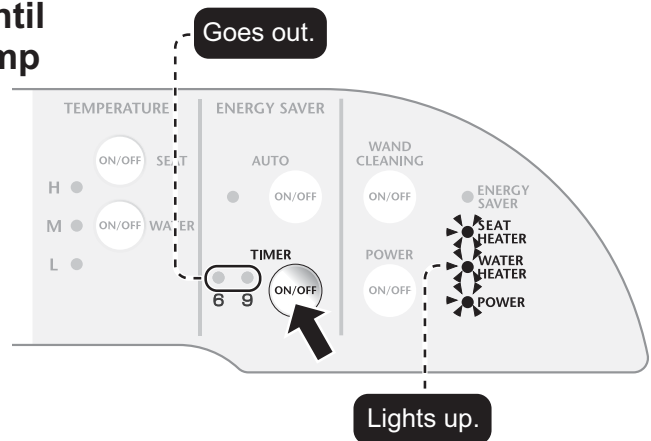

When using the Timer-based Energy Saver and the Smart Energy Saver at the same time

Either button may be pressed first.

1 Set the timer-based energy saver mode.

- ▶ See "Setting the Timer-based Energy Saver" on page 17.

2 Set the smart energy saver mode.

- ▶ See "Setting the Smart Energy Saver" on page 17.

Tip  1

When changing the energy saving start time, cancel the timer-based energy saver mode first, then press the  button again at the time when you want to start saving energy.

Lamp indication during energy saving

Smart Energy Saver mode

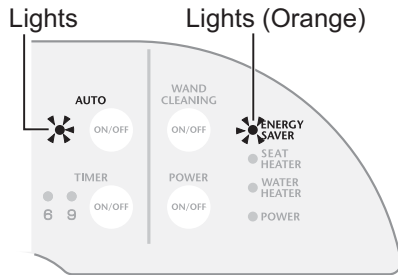

- Seat heater: Low temperature
- Warm water heater: Preset temperature

Timer-based Energy Saver mode (When the timer is set to 6 hours)

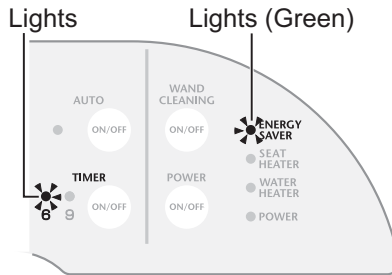

- Seat heater: OFF
- Warm water heater: OFF

During normal operation

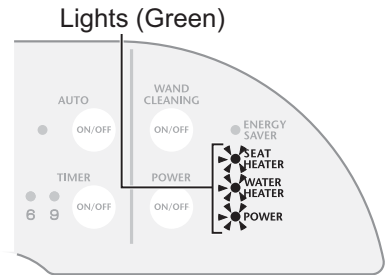

- Seat heater: Preset temperature
- Warm water heater: Preset temperature

Tip 2

Tip 2

When you sit on the seat (the seating switch is on), the Energy Saver indication lamp goes out.

Maintenance

Before cleaning

Attention!

- Clean your Washlet using cleaning detergents and tools suitable to the materials of each part. The wrong way of cleaning may damage your Washlet.

Cleaning the main Washlet unit, seat and lid

Materials: Plastic (resin) or rubber

Basic cleaning tools

Neutral kitchen detergent

Soft cloth



Do not use the following to clean parts made of plastic (resin) or rubber.

- ✗ Thinner, benzine (naphtha), cleanser, nylon scrubber, dry cloth and toilet paper

Cleaning the toilet and tank

Material: Earthenware

Basic cleaning tools

Toilet bowl brush

Toilet bowl cleaner (without abrasive)

Soft cloth



Do not use the following to clean parts made of earthenware.

- ✗ Strong acidic or alkaline detergents, abrasive cleanser, metal brush and nylon scrubber impregnated with abrasive soap

Cleaning the stop valve

Material: Metal

Basic cleaning tool

Soft cloth



Do not use the following to clean metal parts.

- ✗ Scrubber, nylon scrubber, cleanser, scouring powder, detergent containing coarse particles, thinner, benzine (naphtha), chlorine-based detergent and strong alkaline chemicals

For floor-mounted toilet

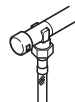

Each part can be detached, allowing for thorough cleaning.

Attention!

For Continental Europe

- Always disconnect the mains plug from the socket when cleaning.
- * Use of the Wand Cleaning function is an exception to this rule.

For United Kingdom

- Always turn off the breaker on the distribution board when cleaning.
- * Use of the Wand Cleaning function is an exception to this rule.

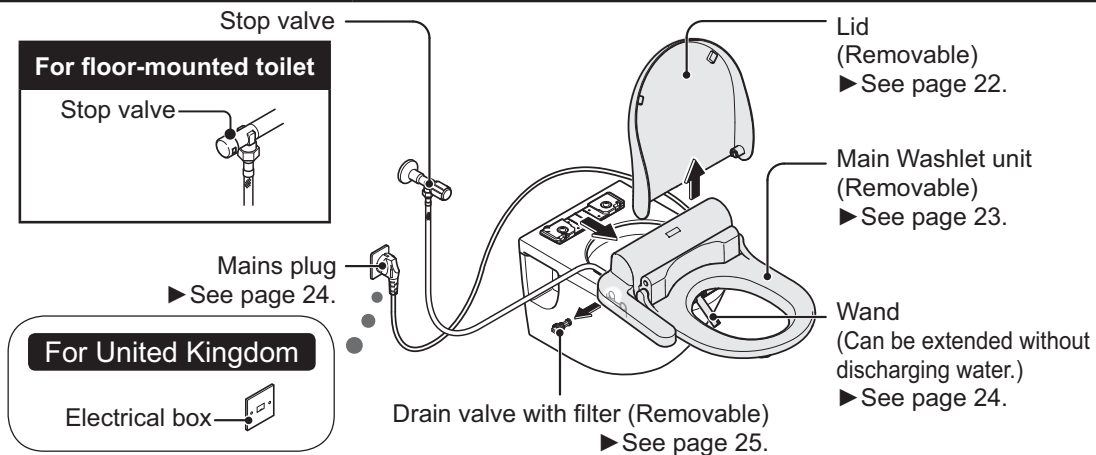

Daily cleaning

Cleaning the main Washlet unit, seat and lid

1

Only for Continental Europe

Disconnect the mains plug.

- * For your safety, disconnect the mains plug before removing the main Washlet unit. In addition, avoid splashing water on the disconnected mains plug.

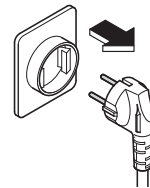

2

Wipe with a soft wet cloth.

- After wetting a soft cloth with water, wring it out thoroughly and then use it to wipe the Washlet.
- Wipe gently while pressing the cloth with your palm and without scratching the surface with your nails.
- Use a thin cloth for wiping the clearance between the main Washlet unit and the lid.

Tip 1

Cleaning when the Washlet is very dirty

- (1) Wipe off dirt with a soft cloth impregnated with diluted kitchen (neutral) detergent.
- (2) After cleaning, wipe again with clean water.

Wipe away any toilet cleanser that spills on the Washlet

- After wiping with a soft cloth dampened with water, wipe away any remaining droplets.



Attention!

When cleaning inside the toilet with cleanser

When cleaning inside the toilet with toilet cleanser, disinfectant or similar substances, flush away the cleaning substances as quickly as possible (within 3 minutes), and then leave the seat and lid open. In addition, be sure to completely remove any cleanser remaining on the toilet. (If vapours from toilet cleansers or similar substances enter the main Washlet unit, this could lead to malfunction.)

Tip 1

- Since the Washlet is made of plastic, do not wipe it with a dry cloth, toilet paper or any similar material. Doing so could cause scratches. Besides, the dirt repellent effect of the wand body may diminish.
- The Washlet is an electric appliance, so be very careful to avoid letting water get inside it. Thoroughly wipe away any cleanser left in gaps between the main unit and the toilet.
- Do not pull the wand cover with excessive force. (This could cause damage or malfunction.)

Thorough cleaning

Cleaning the clearance between the seat and lid

- The lid can be detached for thorough cleaning.

How to detach the lid

1

For Continental Europe

Disconnect the mains plug.

- * For your safety, disconnect the mains plug before removing the main Washlet unit. In addition, avoid splashing water on the disconnected mains plug.

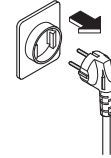

For United Kingdom

Turn off the breaker on the distribution board.

- * For your safety, turn off the breaker on the distribution board before detaching the main Washlet unit.

2

Hold the lid as shown in the figure.

- Tilt the toilet lid slightly toward you to detach easily.

3

1 Pull the left side outward, remove the hinge from the recess and raise the lid.

2 Remove the right side.

- * Pay attention not to pinch your fingers.

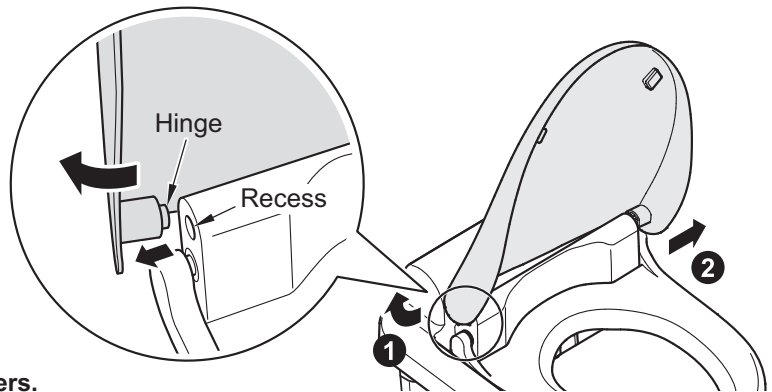

4

Clean the Washlet main unit, seat and lid.

- ▶ See "Cleaning the main Washlet unit, seat and lid" on page 21.

How to attach the lid

1

Fit the pin into the hinge on the right side.

2

Pull the left side outward and fit the hinge in the recess.

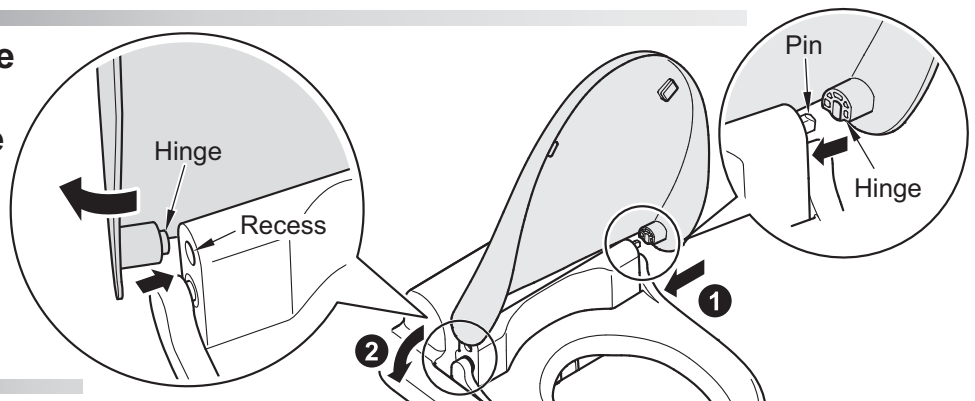

3

For Continental Europe

Reconnect the mains plug.

For United Kingdom

Turn on the breaker on the distribution board.

Cleaning the clearance between the main Washlet unit and the toilet

- About once a month, remove the main Washlet unit to clean the top of the toilet and the bottom of the main Washlet unit.

1

For Continental Europe

Disconnect the mains plug.

- * For your safety, disconnect the mains plug before removing the main Washlet unit. In addition, avoid splashing water on the disconnected mains plug.

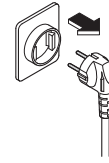

For United Kingdom

Turn off the breaker on the distribution board.

- * For your safety, turn off the breaker on the distribution board before detaching the main Washlet unit.

2

Dismount the main Washlet unit.

- While pressing the Washlet release button on the right side, pull the main Washlet unit forward.
- * When the main Washlet unit is detached, do not turn it over or tip it at a great angle.
- * Do not pull the unit with a lot of force because the water supply hose and power cord are attached to it.

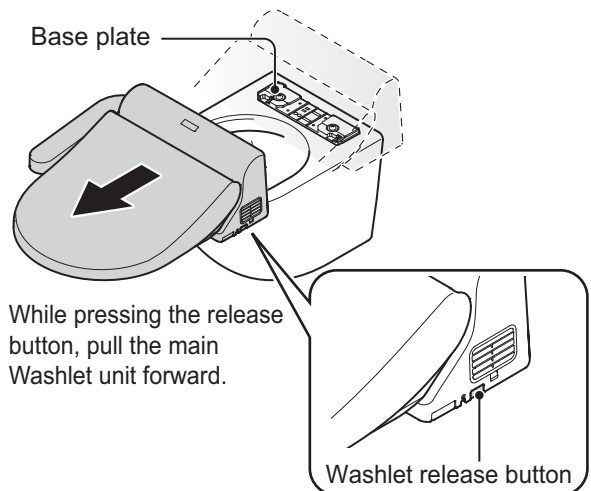

3

Clean the unit.

- ▶ To clean these parts, follow the instructions in "Daily cleaning" on page 21.

4

Reattach the main Washlet unit.

- (1) Align the centre of the main Washlet unit and the centre of the base plate.
 - (2) Slide the main Washlet unit over the top of the toilet to cover the base plate completely, until you hear a click.
- * Pay attention not to pinch the power cord.

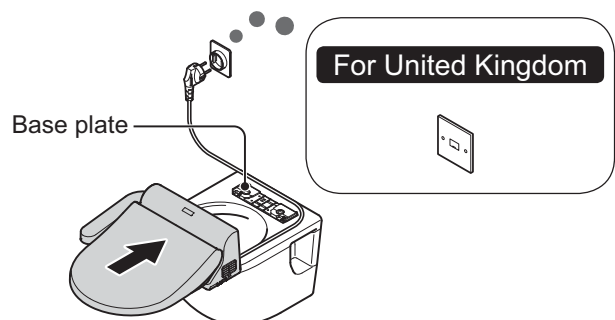

5

For Continental Europe

Reconnect the mains plug.

For United Kingdom

Turn on the breaker on the distribution board.

Periodic cleaning

Only for Continental Europe Cleaning the mains plug

- Clean the mains plug about once a month.

1 Disconnect the mains plug.

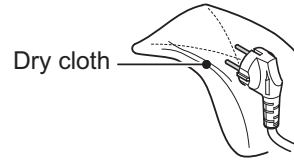

2 Clean the plug.

- Remove dust from the blades and other parts of the mains plug with a dry cloth.

3 Reconnect the mains plug.

- Insert the plug completely.

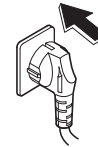

Cleaning the wand

- The wand can be extended without discharging water, making it easy to clean.

1 Press the button on the Washlet main operation unit.

The wand extends.

- Water for cleaning comes out from the root of the wand.
- The wand retracts automatically in about 5 minutes.

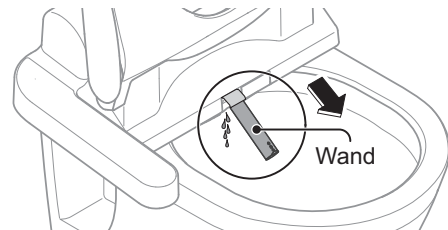
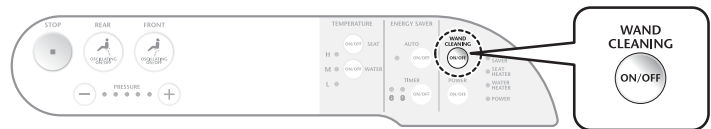

2 Clean the wand.

- Wipe the wand with a soft damp cloth.
- * Do not pull, push or press the wand with excessive force. (This could cause damage or malfunction.)

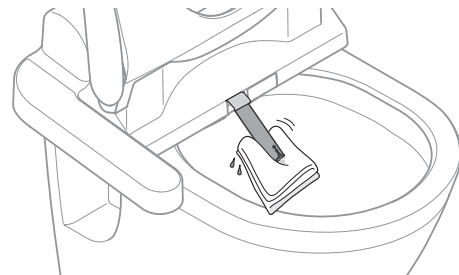

3 Press the button again.

The wand retracts and automatically cleans itself.

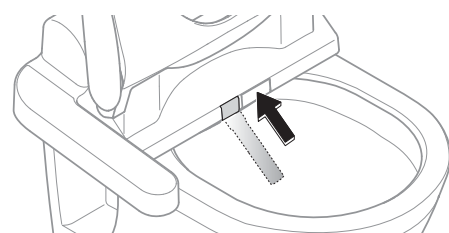



Cleaning the drain valve with filter

- Clean the drain valve with filter if the water pressure during rear or front washing seems to have weakened.

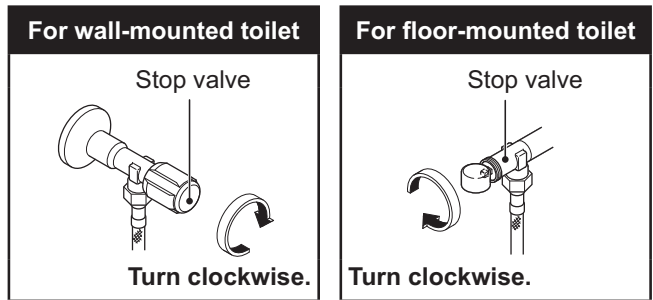
1 Close the stop valve and stop the cold water supply.



2 Drain the water from the Washlet pipes.

- (1) Press the  button on the Washlet main operation unit to make the wand come out. (Pressure is released from the water supply pipe.)
- (2) Press the  button again. (The wand returns to its retracted position.)



3 Detach the drain valve with filter.

- Use a flat-blade screwdriver to loosen the drain valve with filter, and pull it out.

 **CAUTION**

 Do not detach the drain valve with filter while the water stop valve is still open.

- Doing so will cause water to spill.

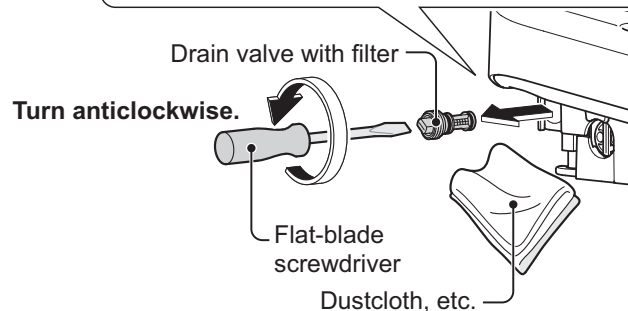
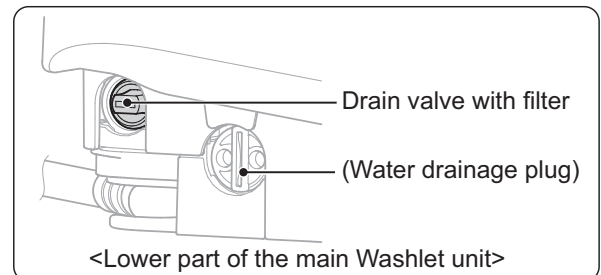

4 Clean the filter.

- Wash off and remove debris caught in the filter of the drain valve with filter.

Tip  1

- * Thoroughly remove the debris on the filter with a toothbrush or similar tool.
- * Use a cotton swab or similar to remove debris from inside the attachment hole for the drain valve with filter.

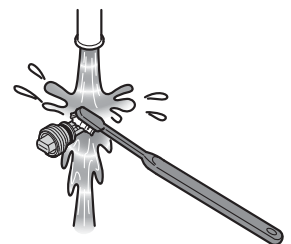



Tip  1

Cleaning the drain valve with filter

- Do not use detergent. Wash with plain water.
- Do not break the filter nor detach it from the drain valve.

5 Reattach the drain valve with filter.

- Insert the drain valve with filter and use a flat-blade screwdriver to tighten it thoroughly.

	CAUTION
	Thoroughly tighten the drain valve with filter. <ul style="list-style-type: none">• Failure to do so could cause a water leak.
Required	

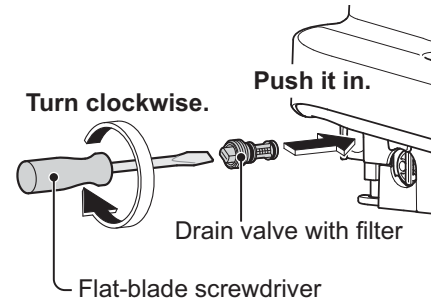

Use a flat-blade screwdriver to tighten it thoroughly.

6 Open the stop valve.

- Open the water stop valve.
- * Confirm that no water is leaking from the plumbing, the main Washlet unit or the drain valve with filter.

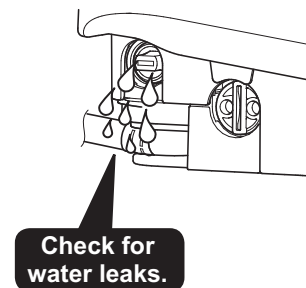
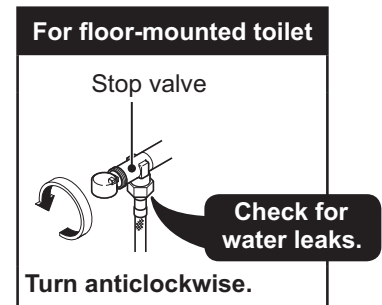
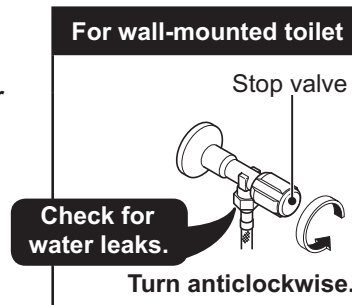

Preventing damage from freezing and measures for long-term disuse

Preparation for freezing conditions Tip 1



Keep the toilet warm, so that the temperature stays above freezing. If this is not possible, drain the water. If you worry that the water might freeze, follow these procedures to prevent damage to the Washlet. If the Washlet freezes, it might suffer damage and water leaks could occur.

Draining the water

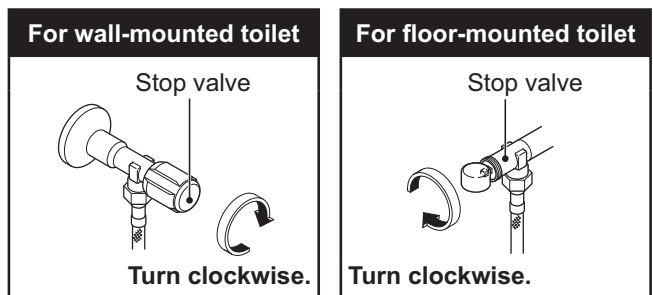
1 Close the stop valve and stop the cold water supply.



2 Drain the water from the Washlet pipes.

- (1) Press the  button on the Washlet main operation unit to make the wand come out. (Pressure is released from the water supply pipe.)
- (2) Press the  button again.
- (3) Use a flat-blade screwdriver to loosen the drain valve with filter and then pull it out.



CAUTION

 Do not detach the drain valve with filter while the water stop valve is still open.

- Doing so will cause water to spill.

Prohibited

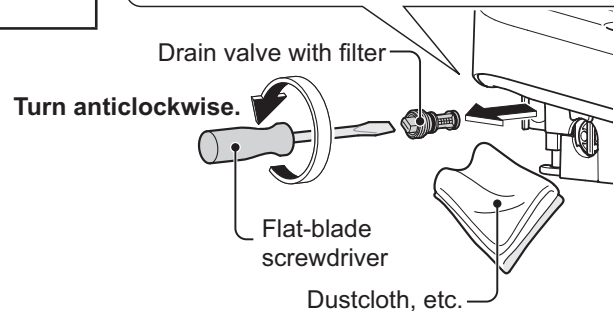
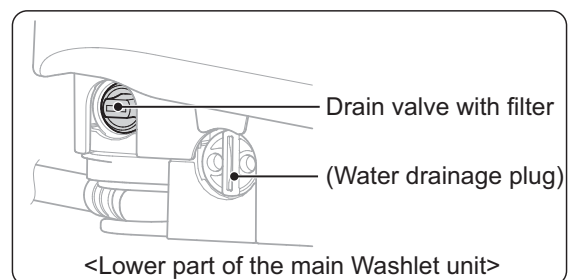

Tip 1



Preparation for freezing conditions

Do not use the Energy Saver functions. The Washlet could be damaged if the water freezes when the heaters are turned off.

► See "When not using the Timer-based Energy Saver" on page 18 for how to turn off the Energy Saver features.

3 Reattach the drain valve with filter.

- Insert the drain valve with filter and use a flat-blade screwdriver to tighten it thoroughly.

 CAUTION
 Required
Thoroughly tighten the drain valve with filter. <ul style="list-style-type: none">• Failure to do so could cause a water leak.

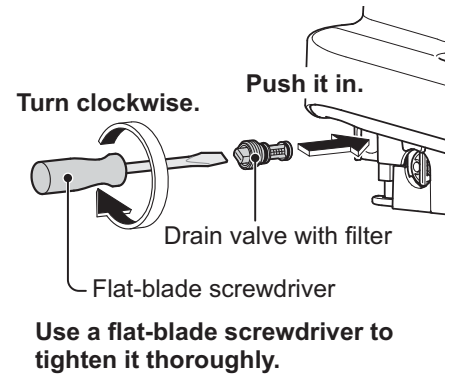

4 Keep the inside of the main Washlet unit warm.

- (1) Make sure that the **POWER** lamp on the Washlet main operation unit is lit and set the temperature setting of the warm water and the seat heaters to **"H"** (high).
 - ▶ See pages 14, 15.

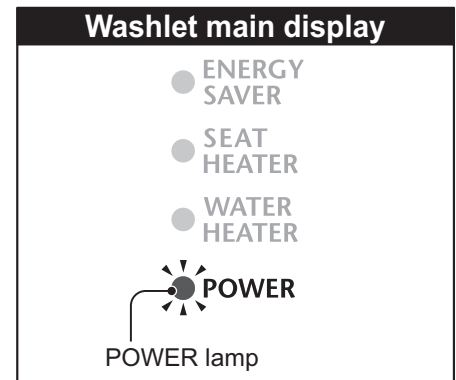

- (2) Close the lid.
 - * After freeze prevention preparations, keep the seat and lid closed.

What to do when not using the Washlet for a long time

- If the Washlet is not used for a long time, water left in it could become contaminated and cause skin inflammation or other problems. You should also drain the water to prevent the Washlet from freezing.

Tip 1

Draining the water

1 Close the stop valve and stop the cold water supply.

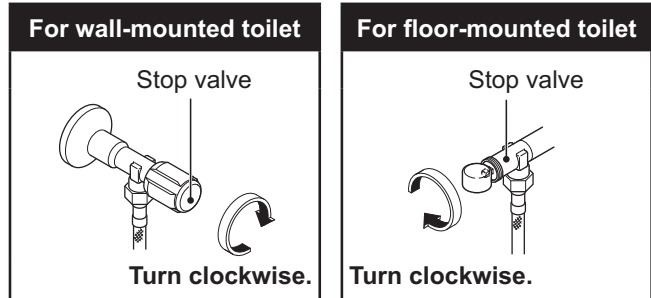

2 Drain the water from the Washlet pipes.

- ▶ See step 2 of "Draining the water" on page 27.

3 For Continental Europe Disconnect the mains plug.

- * For your safety, disconnect the mains plug before removing the main Washlet unit. In addition, avoid splashing water on the disconnected mains plug.

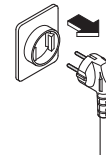

For United Kingdom

Turn off the breaker on the distribution board.

- * For your safety, turn off the breaker on the distribution board before detaching the main Washlet unit.

4 Dismount the main Washlet unit.

- While pressing the Washlet release button on the right side, pull the main Washlet unit forward.
- Rest the detached main Washlet unit on the front half of the top of the toilet.
- * When the main Washlet unit is detached, do not turn it over or tip it at a great angle.
- * Do not pull the unit with a lot of force because the water supply hose and power cord are attached to it.

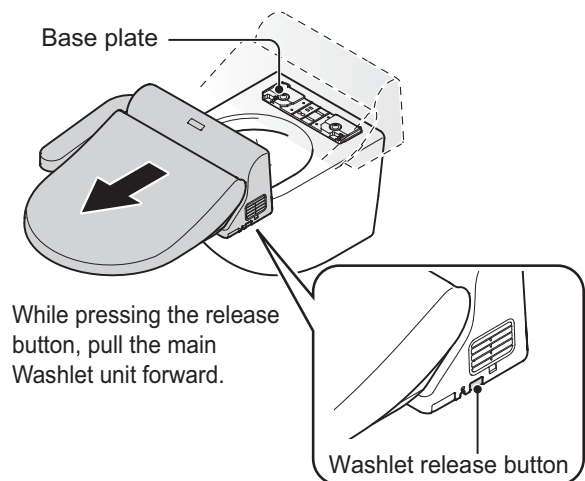

Tip 1

Do not forget to drain the water!

Always drain the water to prevent freezing:

- When leaving home for a long time in the winter.
- When the Washlet is installed in a vacation home or other location that is not always occupied. Empty homes can be very cold in winter.

5 Remove the water drainage plug and drain the water from the main Washlet unit.

- Use a flat-blade screwdriver to loosen the water drainage plug and then pull it forward.
- About 700 ml of water will pour out into the toilet.

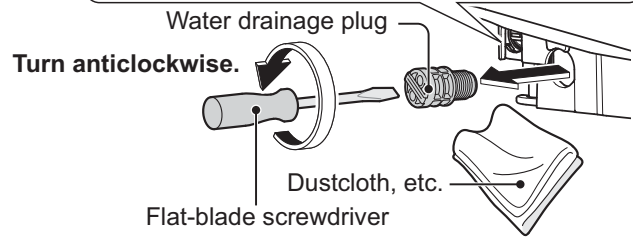
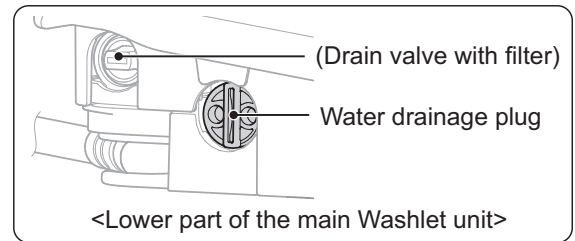

Use a flat-blade screwdriver to loosen the water drainage plug.

6 Reinsert the water drainage plug.

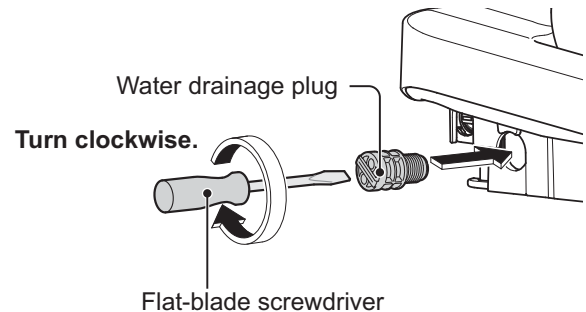

Use a flat-blade screwdriver to tighten it thoroughly.

7 Reattach the main Washlet unit.

- (1) Align the centre of the main Washlet unit and the centre of the base plate.
 - (2) Slide the main Washlet unit over the top of the toilet to cover the base plate completely, until you hear a click.
- * Pay attention not to pinch the power cord.



8 Take proper measures for water remaining in the toilet.

Tip 2

Tip 2

Put antifreeze in the water remaining in the toilet to reduce the chance of freezing.

Restoring the water supply after draining the Washlet

1 Open the stop valve.

- Check that there are no leaks in the plumbing or the main Washlet unit.

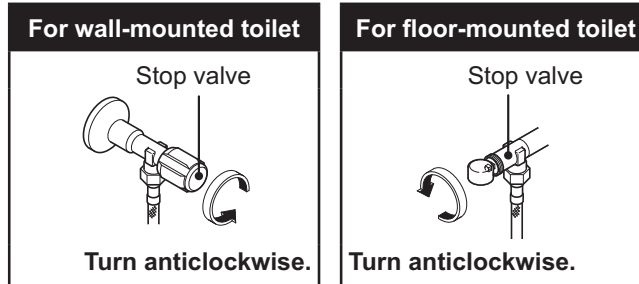

2 Insert the mains plug in the socket.

3 Run water through the wand.

- Press the  button on the Washlet main operation unit while pressing the right side of the seat by hand, and spout water from the wand for 2 minutes.
(It takes about 1 minute to discharge the water from the wand.)
- Collect the spouted water in a paper cup, etc.

Tip  1

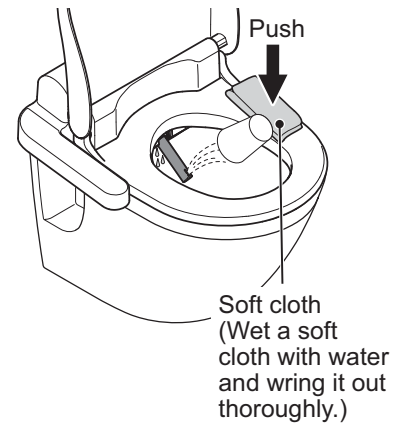



Tip  1

What to do if the remaining water has frozen and no water comes out



Water left in the water supply hose and stop valve might freeze. If this has happened, warm the inside of the toilet and use a cloth soaked in warm water to warm the water supply hose and stop valve.

Troubleshooting

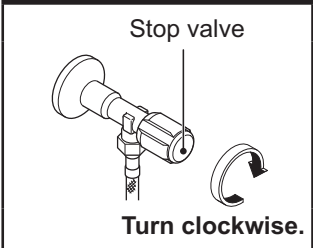
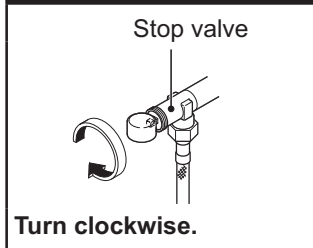
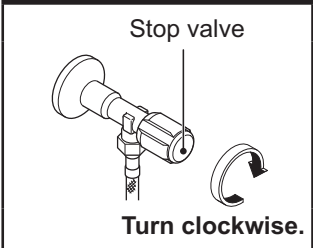
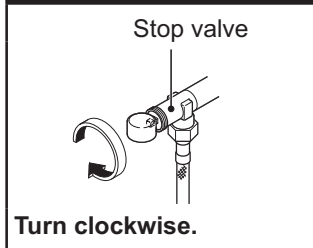
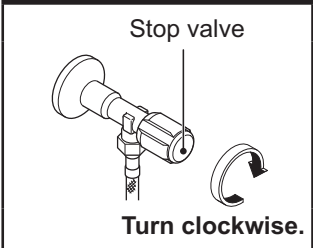
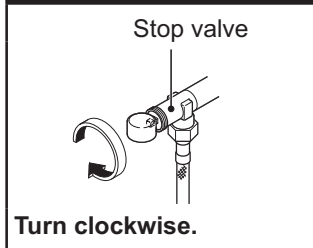
Please read this section to troubleshoot any problem before requesting repairs. If you still cannot solve the problem after reviewing this section, please contact TOTO Europe GmbH (see the back cover for contact information).

 CAUTION					
 Required	<p>If a water leak occurs, close the water shut-off valve to stop the water supply.</p> <table border="1" style="width: 100%;"> <thead> <tr> <th style="text-align: center;">For wall-mounted toilet</th> <th style="text-align: center;">For floor-mounted toilet</th> </tr> </thead> <tbody> <tr> <td style="text-align: center;">  <p>Stop valve</p> <p>Turn clockwise.</p> </td> <td style="text-align: center;">  <p>Stop valve</p> <p>Turn clockwise.</p> </td> </tr> </tbody> </table>	For wall-mounted toilet	For floor-mounted toilet	 <p>Stop valve</p> <p>Turn clockwise.</p>	 <p>Stop valve</p> <p>Turn clockwise.</p>
For wall-mounted toilet	For floor-mounted toilet				
 <p>Stop valve</p> <p>Turn clockwise.</p>	 <p>Stop valve</p> <p>Turn clockwise.</p>				

Please confirm the following two points before requesting repair.

(1) Is the main Washlet unit attached correctly to the base plate?	
<ul style="list-style-type: none"> Are the main Washlet unit and base plate out of alignment? → Remove the main Washlet unit and reattach it to the base plate once. ▶ See page 23. 	
(2) Is the Washlet POWER lamp in the Washlet main display unit lit?	
<ul style="list-style-type: none"> Is the POWER lamp lit? ▶ See page 11. If the POWER lamp is not lit <ul style="list-style-type: none"> Is the Energy Saver indication lamp lit? → The Energy Saver function might be on. ▶ See page 19. Are all lamps unlit? → Follow the steps below to see if the POWER lamp lights up. <div style="background-color: #e0e0e0; padding: 10px; margin-top: 10px;"> <ol style="list-style-type: none"> Press the  button in the Washlet main operation unit. Has there been a power outage or are any of the central power breakers switched off? If there is a power outage, wait until the power comes back on. If the breaker controlling the power to the Washlet is off, turn it back on. </div>	<p>•Check here</p> <div style="border: 1px solid black; padding: 5px; margin-bottom: 10px;"> <p style="text-align: center;">Washlet main display</p> <ul style="list-style-type: none"> ● ENERGY SAVER ● SEAT HEATER ● WATER HEATER <p>POWER lamp  POWER</p> </div> 



If the problem is not resolved after confirming (1) and (2), continue with “Identifying the problem” on the next page.

Identifying the problem

Do rear and front washing work?

Trouble

Washing functions do not work when the rear wash and front wash buttons on the Washlet main operation unit are pressed.

Tests and results		Solutions
Does the wand extend when the  or  buttons are pressed? * If the seating switch does not detect a person, these functions will not work. Please sit on the seat and check.	[If the wand extends but the washing water does not come out (or the water pressure is very weak)] <ul style="list-style-type: none"> Water might not be supplied to the Washlet, or debris could be blocking the wand. 	<ul style="list-style-type: none"> Is the water cut off? Press the  button and wait for restoration from the water failure. Is the stop valve closed? Turn the stop valve anticlockwise to open. <ul style="list-style-type: none"> ▶ See page 10. Clean the drain valve with filter. <ul style="list-style-type: none"> ▶ See page 25.
	[If the wand does not extend] <ul style="list-style-type: none"> It is possible that the seating switch continued detection for a long time and the safety device triggered. 	
It is possible that the seating switch cannot detect the user.		<ul style="list-style-type: none"> The seating switch can have difficulty detecting the user depending on the sitting posture. Sit back on the seat.
Is a commercially available seat cover or lid cover being used?	<ul style="list-style-type: none"> If a commercially available seat cover or lid cover is used, the seating switch may keep detecting the cover/lid for a long time and the seat heater and rear washing functions may be disabled by safety features. 	<ul style="list-style-type: none"> Remove the commercially available cover.

Do the Energy Saver features work?

Trouble

The Timer-based Energy Saver or the Smart Energy Saver is not working.

Tests and results		Solutions
Is the breaker switched off or has there been a power outage?	<ul style="list-style-type: none"> The setting may be cancelled. 	<ul style="list-style-type: none"> Set the Timer-based Energy Saver again. (When the power is turned off, the Timer-based Energy Saver lamp flickers to indicate that the power is "OFF".)

Trouble

The Smart Energy Saver is not working.

Tests and results		Solutions
When the Smart Energy Saver setting is "ON", the Washlet learns the status of use over several days and determines the energy-saving time slot. Therefore, the energy saver feature may not have had enough time to determine the energy saver time slot depending of the frequency of use.		<ul style="list-style-type: none"> See "Energy saver functions" ▶ Page 16.

The seat temperature is cold.

Trouble The seat does not warm up (remains cold).

Tests and results		Solutions
Is the seat temperature setting low or "OFF"?		<ul style="list-style-type: none"> Adjust the temperature by pressing the  button on the Washlet main operation section. <ul style="list-style-type: none"> ▶ See pages 14, 15.
Is the Energy Saver ON/OFF lamps on the Washlet main operation section lit?	[If the Energy Saver indication lamp and Timer-based Energy Saver lamp are lit] <ul style="list-style-type: none"> The seat heater is turned off to save energy. (Timer-based Energy Saver "ON") 	<ul style="list-style-type: none"> When you sit on the seat, the heater is turned on temporarily and the seat is warmed in about 15 minutes. <ul style="list-style-type: none"> ▶ See pages 16, 17.
	[If the Energy Saver indication lamp and Smart Energy Saver ON/OFF lamp are lit] <ul style="list-style-type: none"> The seat temperature is lowered to save energy. (Smart Energy Saver "ON") 	<ul style="list-style-type: none"> When you sit on the seat, the seat is warmed temporarily. <ul style="list-style-type: none"> ▶ See pages 16, 17.
Have you been seated for a long time?	<ul style="list-style-type: none"> If the seating switch continuously detects something for longer than 20 minutes, the seat temperature lowers and, if it detects something continuously for longer than 1 hour, the safety device triggers to turn off the seat heater. 	<ul style="list-style-type: none"> Stand up once from the seat and use it again.
Did you put anything on the seat or the lid?		<ul style="list-style-type: none"> Remove the object from the seat or the lid.
Are you sitting in a way that prevents the seating switch from working?		<ul style="list-style-type: none"> The seating switch can have difficulty detecting the user depending on the sitting posture. Sit back on the seat.
Is a commercially available seat cover or lid cover being used?	<ul style="list-style-type: none"> If a commercially available seat cover or lid cover is used, the seating switch may keep detecting the cover/lid for a long time and the seat heater and rear washing functions may be disabled by safety features. 	<ul style="list-style-type: none"> Remove the commercially available cover.

The washing water temperature is cold.

Trouble The rear or front washing water is cold.

Tests and results		Solutions
Is the water temperature setting low or OFF?		<ul style="list-style-type: none"> Adjust the temperature by pressing the  button on the Washlet main operation section. <ul style="list-style-type: none"> ▶ See pages 14, 15.
Is the Timer-based Energy Saver ON?		<ul style="list-style-type: none"> Sit on the seat and wait for about 10 minutes. <ul style="list-style-type: none"> ▶ See page 16.
Is the washing water cold only in the beginning?		<ul style="list-style-type: none"> When the temperature of the water supply and the bathroom is low, the water temperature may be low when first spouted.

The rear and front washing water pressure is weak.

Trouble The washing water pressure is weak.	
Tests and results	Solutions
Is the water pressure set to a low level?	<ul style="list-style-type: none"> Adjust the water pressure by pressing the  button on the Washlet main operation unit. <ul style="list-style-type: none"> ▶ See page 12.
Is the drain valve with filter blocked?	<ul style="list-style-type: none"> Clean the drain valve with filter. <ul style="list-style-type: none"> ▶ See page 25.
Is the stop valve closed?	<ul style="list-style-type: none"> Turn the stop valve anticlockwise to open it. <ul style="list-style-type: none"> ▶ See page 10.
Is the water drainage plug loosened?	<ul style="list-style-type: none"> Tighten the water drainage plug securely. <ul style="list-style-type: none"> ▶ See page 30.

Rear or front washing starts and stops on its own.

Trouble Rear or front washing suddenly stops during use.			
Tests and results	Solutions		
<table border="1"> <tr> <td>Have you been using it for a long time?</td> <td> <ul style="list-style-type: none"> Rear and front washing stop automatically after using continuously about 5 minutes. </td> </tr> </table>	Have you been using it for a long time?	<ul style="list-style-type: none"> Rear and front washing stop automatically after using continuously about 5 minutes. 	<ul style="list-style-type: none"> Press the button again.
Have you been using it for a long time?	<ul style="list-style-type: none"> Rear and front washing stop automatically after using continuously about 5 minutes. 		
Are you sitting in a way that prevents the seating switch from working?	<ul style="list-style-type: none"> If you get up slightly from the seat, or sit forward on the seat, the seating switch might temporarily stop detecting your presence. Sit fully on the seat. 		

Trouble Water comes out of the wand when it should not.	
Tests and results	Solutions
When you stand up from the toilet seat, water remaining in the wand is drained out (for about 30 seconds) to keep the wand clean for use every time.	—
Water sometimes comes out around the wand. This occurs due to expansion of the water in the warm water tank.	—

Other situations

Trouble A sound is heard when you sit on the toilet seat.	
Tests and results	Solutions
This is the sound that activates the seating switch.	► See page 7.
Trouble The speed with which the seat and lid close changes between summer and winter.	
Tests and results	Solutions
The speed might change slightly due to the room temperature or frequency of use.	—
Trouble The main Washlet unit feels loose.	
Tests and results	Solutions
Are the bolts in the base plate that fixes the main Washlet unit to the toilet loose?	• Securely retighten the bolts.
To activate the seating switch, there is clearance between the seat cushion and the toilet. When you sit on the seat, the seat is slightly lowered and the seating switch turns on.	► See page 7.
Trouble Water is leaking from the plumbing connections.	
Tests and results	Solutions
Is a plumbing connection nut loose?	<ul style="list-style-type: none"> • Use a monkey wrench or similar tool to tighten the loose part. * If the water leak does not stop, close the stop valve and request repairs.

Specifications

Rated power		220 – 240 V AC, 50 Hz	
Rated power consumption		269 – 315 W	
Standard power consumption per year *		180 (250) kWh/year *	
Power cord length		About 1.0 m	
Washlet equipment	Spray volume	Rear wash	About 0.29 – 0.60 L/min
		Front wash	About 0.27 – 0.55 L/min
	Spray temperature		Temperature adjustment range : OFF, about 35 – 40°C
	Heater capacity		195 – 232 W
	Water tank capacity		0.78 L
	Safety equipment		Temperature fuse, overheat protector (automatic reset type bimetal), float switch to prevent heating when empty
Backflow prevention equipment		Vacuum breaker, Air gap	
Heated seat	Surface temperature		Temperature adjustment range : OFF, about 28 – 35°C (About 26°C in energy saving)
	Heater capacity		45 – 54 W
	Safety equipment		Temperature fuse
Water pressure		0.1 – 1.0 MPa	
Water temperature		0 – 35°C	
Operating ambient temperature		0 – 40°C	
Dimensions		480 mm (width), 527 mm (depth), 173 mm (height)	
Weight		TCF6402G About 5.5 kg TCF6402GE About 5.2 kg	

* The value was measured according to the Law concerning the Rational Use of Energy (2012 standard) in Japan. Standard power consumption per year without the energy saver functions is shown in the brackets.

Warranty

LIMITED TWO YEARS WARRANTY

1. TOTO warrants its products to be free from manufacturing defects under normal use and service for a period of two (2) years from the date of purchase. This warranty is extended only to the ORIGINAL PURCHASER.
2. TOTO's obligations under this warranty are limited to repair or replacement, at TOTO's option, of products or parts found to be defective, provided that such products were properly installed and used in accordance with this OWNER'S MANUAL. TOTO reserves the right to make such inspections as may be necessary to determine the cause of the defect. TOTO will not charge for labour or parts in connection with warranty repairs or replacements.
TOTO is not responsible for the cost of removal, return and/or reinstallation of products.
3. This warranty does not apply to the following items:
 - a) Damage or loss sustained in a natural calamity such as fire, earthquake, flood, thunder, electrical storm, etc.
 - b) Damage or loss resulting from any unreasonable use, misuse, abuse, negligence, or improper maintenance of the product.
 - c) Damage or loss resulting from removal, improper repair, or modification of the product.
 - d) Damage or loss resulting from sediments or foreign matter contained in a water system.
 - e) Damage or loss resulting from improper installation or from installation of a unit in a harsh and/or hazardous environment.
4. This warranty gives you specific legal rights. You may have other rights which vary from country to country.
5. To obtain warranty repair service under this warranty, you must take the product or deliver it prepaid to a TOTO service facility, together with a letter stating the problem, or contact a TOTO distributor or product service contractor, or directly to a TOTO sales office. If, because of the size of the product or nature of the defect, the product cannot be returned to TOTO, receipt by TOTO of a written notice of the defect shall constitute delivery. In such case, TOTO may choose to repair the product at the purchaser's location or pay to transport the product to a service facility.

THIS WRITTEN WARRANTY IS THE ONLY WARRANTY MADE BY TOTO. REPAIR OR REPLACEMENT AS PROVIDED UNDER THIS WARRANTY SHALL BE THE EXCLUSIVE REMEDY AVAILABLE TO THE PURCHASER. TOTO SHALL NOT BE RESPONSIBLE FOR LOSS OF USE OF THE PRODUCT OR FOR OTHER INCIDENTAL, SPECIAL, OR CONSEQUENTIAL DAMAGE OR EXPENSES INCURRED BY THE PURCHASER, OR FOR LABOUR OR OTHER COSTS DUE TO INSTALLATION OR REMOVAL, OR COSTS OF REPAIRS BY OTHERS, OR FOR ANY OTHER EXPENSE NOT SPECIFICALLY STATED ABOVE. EXCEPT TO THE EXTENT PROHIBITED BY APPLICABLE LAW, ANY IMPLIED WARRANTIES, INCLUDING THAT OF MERCHANTABILITY OR FITNESS FOR USE, ARE EXPRESSLY LIMITED TO THE DURATION OF THIS WARRANTY. SOME NATIONS DO NOT ALLOW LIMITATIONS ON HOW LONG AN IMPLIED WARRANTY LASTS, OR THE EXCLUSION OR LIMITATION OF INCIDENTAL OR CONSEQUENTIAL DAMAGE, SO THE ABOVE LIMITATION AND EXCLUSION MAY NOT APPLY TO YOU.



Important User Guidance Information



If you want to dispose this product, do not mix it with general household waste. There is a separate collection system for used electronic products in accordance with legislation that requires proper treatment, recovery and recycling.

Private households in the member states of the EU, Switzerland and Norway may return their used electronic products free of charge to designated collection facilities or to a retailer (if you purchase a similar new one).

For countries not mentioned above, please contact your local authorities for the correct method of disposal.

By doing so you will ensure that your disposed product undergoes the necessary treatment, recovery and recycling, which prevent potential negative effects on the environment and human health.

Only discard discharged batteries. They should not be disposed of with household waste, but rather at appropriate collection sites or at the product retailer.

TOTO®

Head Office

TOTO Europe GmbH
Armelerstr. 20-22, D-46242 Bottrop Germany
Tel:+49 (0)700 8686 0700

- You are advised to record the following information to allow quick service.

Date of purchase :	Name of shop :
Date : year month day	Tel :

2011.4.13

D08578

Printed in China.