

TOTO

**Installation Guide
Installationsanleitung
Guide d'installation
Manuale di installazione**

NEOREST BATHTUB

PJY1866PWE

PJY1866HPWE

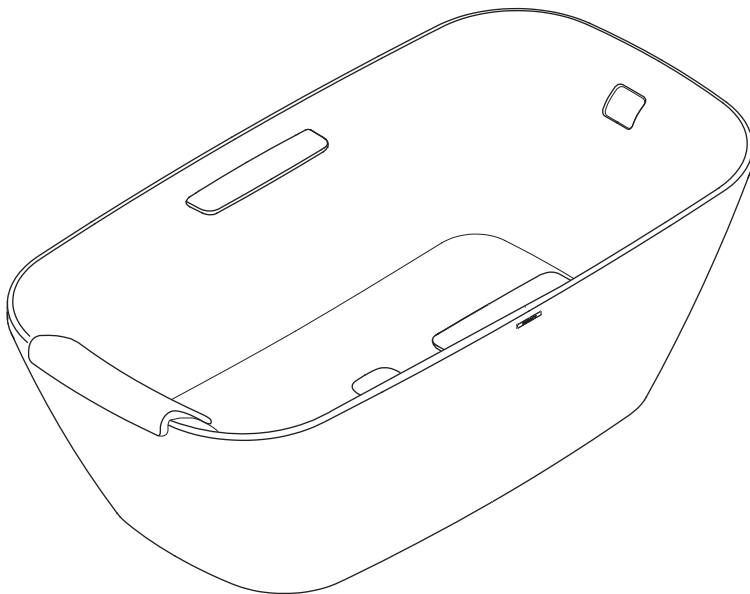



Cautions and warnings. 2
Vorsichtsmaßnahmen und Warnungen . . . 4
Mises en garde et avertissements. . . 6
Avvisi di pericolo e attenzione. . . . 8
**Included parts / Mitgelieferte Teile /
 Pièces fournies / Parti in dotazione. . . 10**
**Required tools / Erforderliches Werkzeug /
 Outils requis / Utensili richiesti 10**
**Specifications / Spezifikationen /
 Caractéristiques / Specifiche tecniche . . . 11**
**Dimension Drawings / Abmessungen /
 Schémas des dimensions / Schemi
 dimensionali 12**
**Installation Procedure / Installation /
 Procédure d'installation / Procedura di
 installazione. 13**
**Meaning of the indications / Bedeutung der
 Hinweise / Signification des indications /
 Significato delle indicazioni 13**
**Building a base for the bathtub ~ seating
 the bathtub /
 Schaffen einer Bodenfläche für die
 Badewanne ~ Aufstellen der Badewanne /
 Fabrication d'une base pour la baignoire ~
 installation de la baignoire /
 Realizzazione di una base in muratura per la
 vasca da bagno ~ posa della vasca da bagno
 14**
**Finishing / Fertigstellung / Finition /
 Operazioni finali 16**
**Pillow / Kissen/Oreiller / Cuscino
 18**

To installation contractors:		Für Installateure:	
Please explain to the customer the functions of the BATHTUB and how to use them.		Erklären Sie dem Kunden bitte die Funktions- und Bedienungsweise des BATHTUBs.	
Aux prestataires d'installation:		Per gli installatori:	
Veuillez expliquer au client les fonctions du BATHTUB et comment les utiliser.		Si prega di illustrare ai clienti le funzioni del BATHTUB e le loro modalità di utilizzo.	

Cautions and warnings



Before installing your BATHTUB, be sure to read the following installation instructions. Install the product only as described in this guide.



Follow all safety precautions and warnings.

 WARNING	<p>When this appears next to a topic, this indicates that misoperation could result in death or serious injury.</p>	 CAUTION	<p>When this appears next to a topic, this indicates that misoperation may result in injury or physical damage.</p>
---	---	---	---

Symbol example



	<p>The  symbol indicates something that is prohibited.</p>		<p>The  symbol indicates something that must be done.</p>
---	---	---	--

 WARNING	
 Prohibited	<ul style="list-style-type: none"> Do not install the tub with the rim surface as its sole support. (Doing so could cause damage.) Do not stand on bathtub while working. (Doing so could cause one to slip and fall or could otherwise damage the product.) Only assemble the parts delivered or indicated. Do not change these parts. (In particular, do not change the dimensions.)
 Required	<ul style="list-style-type: none"> Install securely, in accordance with the Installation Guide. (It could cause water leaks that damage or ruin household property.) Install the drainage pipes securely, in accordance with the procedure. (Improper installation could lead to leaks that damage or ruin household property.) After unpacking, immediately dispose of unwanted packaging materials. (There is a risk of injury from the wooden frame, nails, cardboard boxes, vinyl bags or sealing straps. Additionally, ensure that children do not play with the packaging materials as this could lead to suffocation or other accidents.) Install the bathtub securely in a stable location that can bear the weight of the bathtub in accordance with the Installation Guide. Ensure that you have an ergonomic working position during transport and assembly. (Take care at every stage that your move is safe. Ensure that you have assistance to avoid risk of accident or injury.) Observe the current local prevention of accidents and building regulations as well as sanitary and environmental protection rules during installation.





 CAUTION	
 Prohibited	<ul style="list-style-type: none"> Do not place anything heavy on the tub or anything in the tub for standing on. (Doing so could cause damage.)
	<ul style="list-style-type: none"> Do not drop any heavy or hard objects in the bathtub. (Injury may result from cracks in the bathtub or leaking water may contaminate or ruin household property.)
	<ul style="list-style-type: none"> Keep sources of heat at a distance. Do not smoke. (Otherwise there is a risk of damage.)
	<ul style="list-style-type: none"> Do not install the bathtub outdoors or in a location where it will be constantly exposed to sunlight (for example, in a sunroom). (Otherwise there is a risk of frost damage or discoloration.)
	<ul style="list-style-type: none"> When transporting the bathtub, do not carry by the hoses or plumbing or strike it with anything hard.
 Required	<ul style="list-style-type: none"> Before installing the bathtub, check the bathtub and pipes for damage or abnormality. (Do not assemble any damaged or abnormal components. Obtain replacement parts.)
	<ul style="list-style-type: none"> Do not remove the protective sheet on the bathtub until installation is complete.
	<ul style="list-style-type: none"> Ensure the bathtub can be used and maintained adequately.
	<ul style="list-style-type: none"> Check for leaks after installation is complete. (Shut off the water supply if you discover any leaks and immediately repair them.)



Vorsichtsmaßnahmen und Warnungen

Lesen Sie vor der Installation Ihres BATHTUB die folgenden Installationsanweisungen bitte gut durch. Installieren Sie das Produkt bitte nur so, wie es in der Anleitung beschrieben ist. Beachten Sie bitte alle Vorsichtsmaßnahmen und Warnungen.



 WARNUNG	Wenn ein Abschnitt mit diesem Symbol gekennzeichnet ist, wird darauf hingewiesen, dass bei fehlerhafter Handhabung die Gefahr von schweren oder gar tödlichen Verletzungen besteht.	 VORSICHT	Wenn ein Abschnitt mit diesem Symbol gekennzeichnet ist, wird darauf hingewiesen, dass bei fehlerhafter Handhabung möglicherweise Verletzungsgefahr oder die Gefahr von Sachschäden besteht.
---	---	--	--

Beispielsymbole

	Das Symbol  gibt an, dass etwas verboten ist.		Das Symbol  weist auf etwas hin, das getan werden muss.
---	--	---	--

 WARNUNG	
 Verboten	<ul style="list-style-type: none"> • Installieren Sie die Badewanne nicht so, dass sie nur vom Badewannenrand selbst gestützt wird. (Dies könnte ansonsten zu Schäden führen.) • Stellen Sie sich beim Arbeiten nicht auf die Badewanne. (Andernfalls könnten Sie ausrutschen und stürzen oder Sie können das Produkt beschädigen.) • Verwenden Sie bei der Montage nur die mitgelieferten und abgebildeten Teile. Tauschen Sie diese Teile nicht aus. (Verändern Sie insbesondere die Abmessungen nicht.)
 Erforderlich	<ul style="list-style-type: none"> • Installieren Sie das Produkt sicher und befolgen Sie die in dieser Installationsanleitung enthaltenen Anweisungen. (Darüber hinaus können undichte Stellen entstehen, wodurch Ihr Hausrat beschädigt oder zerstört werden könnte.) • Installieren Sie die Abflussrohre sicher und befolgen Sie die in diesem Handbuch beschriebene Vorgehensweise. (Eine unsachgemäße Installation kann undichte Stellen verursachen, wodurch Ihr Hausrat beschädigt oder zerstört werden könnte.) • Werfen Sie Verpackungsmaterial, das Sie nicht mehr benötigen, nach dem Auspacken des Produkts gleich weg. (An den Holzrahmen, Nägeln, Kartons, Plastikverpackungen und Verschlussbändern können Sie sich ansonsten verletzen. Stellen Sie zudem sicher, dass Kinder nicht mit dem Verpackungsmaterial spielen, da dabei die Gefahr besteht, dass sie ersticken oder dass sich andere Unfälle ereignen.) • Installieren Sie die Badewanne sicher an einem stabilen Platz, der das Gewicht der Badewanne in Übereinstimmung mit der Installationsanleitung tragen kann. • Nehmen Sie während des Transports und der Montage eine ergonomische Haltung ein. (Bewegen Sie sich mit Umsicht. Stellen Sie sicher, dass Sie Hilfe haben, um der Gefahr von Unfällen oder Verletzungen vorzubeugen.) • Beachten Sie bei der Installation die jeweils gültigen Bestimmungen zur Verhütung von Unfällen, die Baubestimmungen, die Sanitärbestimmungen sowie die Bestimmungen zum Umweltschutz.



 **VORSICHT**

 Verboten	<ul style="list-style-type: none"> • Stellen Sie keine schweren Gegenstände auf die Badewanne und keine Gegenstände, auf die Sie daraufsteigen, in die Badewanne. (Dies könnte ansonsten zu Schäden führen.)
	<ul style="list-style-type: none"> • Lassen Sie keine schweren oder harten Gegenstände in die Badewanne fallen. (Risse in der Badewanne können zu Verletzungen führen und austretendes Wasser kann Ihren Hausrat beschädigen oder zerstören.)
	<ul style="list-style-type: none"> • Bringen Sie keine Wärmequellen in die Nähe der Badewanne. Rauchen Sie nicht. (Ansonsten kann die Badewanne beschädigt werden.)
	<ul style="list-style-type: none"> • Installieren Sie die Badewanne nicht im Freien oder an einem Ort, an dem Sie dauerhaft Sonnenlicht ausgesetzt ist (z. B. einer Glasveranda). (Ansonsten kann die Badewanne beschädigt oder verfärbt werden.)
	<ul style="list-style-type: none"> • Wenn Sie die Badewanne transportieren, halten Sie sie nicht an den Schläuchen oder Rohren und stoßen Sie nicht mit festen Gegenständen auf bzw. gegen die Badewanne.
 Erforderlich	<ul style="list-style-type: none"> • Überprüfen Sie vor der Installation die Badewanne und die Rohre, um sicherzustellen, dass keine Schäden o. Ä. vorliegen. (Bauen Sie keine beschädigten oder abnormalen Bauteile ein. Fordern Sie in diesem Fall Ersatzteile an.)
	<ul style="list-style-type: none"> • Entfernen Sie den Schutz auf der Badewanne nicht bis die Installation abgeschlossen ist.
	<ul style="list-style-type: none"> • Stellen Sie sicher, dass die Badewanne richtig benutzt und instandgehalten werden kann. • Überprüfen Sie das Produkt nach abgeschlossener Installation auf undichte Stellen. (Schließen Sie die Wasserzufuhr, wenn Sie undichte Stellen entdecken, und lassen Sie das Produkt umgehend reparieren.)





Mises en garde et avertissements



Avant d'installer votre BATHTUB, assurez-vous de lire les instructions d'installation suivantes. Installez ce produit en suivant exclusivement la procédure décrite dans ce guide.

Suivez toutes les précautions et les avertissements de sécurité.

	Lorsque ce symbole apparaît en regard d'une rubrique, cela indique que toute utilisation incorrecte pourrait entraîner la mort ou une blessure grave.		Lorsque ce symbole apparaît en regard d'une rubrique, cela indique que toute utilisation incorrecte peut entraîner une blessure ou un dommage physique.
AVERTISSEMENT		MISE EN GARDE	



Exemple de symbole

	Le symbole  indique que quelque chose est interdit.		Le symbole  indique que quelque chose doit être fait.
---	--	---	--

 AVERTISSEMENT	
 Interdit	<ul style="list-style-type: none"> • N'installez pas la baignoire avec la surface périphérique comme unique support. (Cela pourrait provoquer des dégâts.) • Ne montez pas sur la baignoire pendant que vous travaillez. (Vous risqueriez de glisser et de tomber ou d'endommager le produit.) • Assemblez exclusivement les pièces fournies ou indiquées. Ne modifiez pas ces pièces. (En particulier, ne modifiez pas les dimensions.)
 Requis	<ul style="list-style-type: none"> • Installez convenablement, conformément au Guide d'installation. (Sinon, cela pourrait entraîner des fuites susceptibles de provoquer des dégâts matériels éventuellement irréversibles.) • Installez convenablement les tuyaux de vidange, conformément à la procédure. (Une installation incorrecte pourrait entraîner des fuites susceptibles de provoquer des dégâts matériels éventuellement irréversibles.) • Après le déballage, veuillez immédiatement mettre au rebut les emballages inutiles. (Vous risqueriez de vous blesser avec les cadres en bois, clous, boîtes en carton, sacs en vinyle ou sangles de scellage. Par ailleurs, veillez à ce que les enfants ne jouent pas avec les emballages, car ils risqueraient de s'étouffer ou de provoquer d'autres accidents.) • Installez convenablement la baignoire dans un endroit stable pouvant supporter son poids conformément au Guide d'installation. • Pendant le transport et l'assemblage, adoptez une position de travail ergonomique. (A chaque étape, soyez attentif à ce que vos mouvements s'effectuent en toute sécurité. Veillez à vous faire aider pour éviter tout risque d'accident ou de blessure.) • Lors de l'installation, respectez les réglementations locales en vigueur en matière d'accidents et de constructions, ainsi que les règlements sanitaires et de protection de l'environnement.





MISE EN GARDE

 Interdit	<ul style="list-style-type: none"> • Ne placez rien de lourd sur la baignoire et ne placez rien dans la baignoire afin de monter dessus. (Cela pourrait provoquer des dégâts.)
	<ul style="list-style-type: none"> • Ne laissez pas tomber d'objets lourds ou durs dans la baignoire. (Les fissures dans la baignoire risqueraient de vous blesser et une fuite pourrait souiller vos biens ou les endommager de manière irréversible.)
	<ul style="list-style-type: none"> • Eloignez toute source de chaleur. Ne fumez pas. (Vous risqueriez de provoquer des dégâts.)
	<ul style="list-style-type: none"> • N'installez pas la baignoire à l'extérieur ou dans un endroit où elle sera exposée en permanence aux rayons du soleil (par exemple, dans une véranda). (Cela risquerait de provoquer des dégâts dus au gel ou une décoloration.)
	<ul style="list-style-type: none"> • Lors du transport de la baignoire, ne la portez pas par les tuyaux ou la tuyauterie et ne la heurtez pas avec un objet dur.
 Requis	<ul style="list-style-type: none"> • Avant d'installer la baignoire, vérifiez-la ainsi que la tuyauterie, à la recherche d'éventuels dégâts ou anomalies. (N'assemblez pas de composants endommagés ou anormaux. Procurez-vous des pièces de rechange.)
	<ul style="list-style-type: none"> • Ne retirez la feuille protectrice de la baignoire qu'une fois l'installation terminée.
	<ul style="list-style-type: none"> • Vérifiez que la baignoire peut être correctement utilisée et entretenue.
	<ul style="list-style-type: none"> • Une fois l'installation terminée, recherchez les fuites éventuelles. (Si vous détectez une fuite, coupez l'alimentation en eau et réparez-la immédiatement.)



Avvisi di pericolo e attenzione



Prima di installare il BATHTUB, leggere le seguenti istruzioni di installazione. Per l'installazione, adottare esclusivamente le procedure riportate nel presente manuale.

Rispettare tutte le istruzioni di sicurezza e le indicazioni riportate negli avvisi.



 PERICOLO	<p>I paragrafi preceduti da questa indicazione contengono descrizioni importanti. In caso di inosservanza, si possono verificare gravi infortuni, anche mortali.</p>	 ATTENZIONE	<p>I paragrafi preceduti da questa indicazione contengono descrizioni importanti. In caso di inosservanza, si possono verificare infortuni o danni alle cose.</p>
--	--	--	---

Esempio di simbolo



	<p>Il simbolo  indica operazioni vietate.</p>		<p>Il simbolo  indica operazioni che devono essere eseguite obbligatoriamente.</p>
---	--	---	---

 PERICOLO	
 Vietato	<ul style="list-style-type: none"> • Non installare la vasca utilizzando solo i bordi come supporto. (Diversamente si potrebbero provocare danni). • Non salire in piedi sulla vasca durante l'esecuzione. (In caso contrario, si potrebbe scivolare e cadere, o danneggiare il prodotto). • Montare soltanto i componenti compresi nella fornitura o indicati nella documentazione. Non sostituire i componenti. (In particolare, non apportare variazioni dimensionali.)
 Obbligatorio	<ul style="list-style-type: none"> • Eseguire l'installazione in modo sicuro, attenendosi alle istruzioni del Manuale di installazione. (In caso contrario si potrebbero verificare fuoriuscite d'acqua, con conseguenti danni agli oggetti o all'edificio). • Eseguire l'installazione dei tubi di scarico in modo sicuro, attenendosi alle procedure. (In caso di installazione scorretta si potrebbero verificare perdite, con conseguenti danni agli oggetti o all'edificio). • Dopo aver disimballato il prodotto, smaltire immediatamente i materiali per imballaggio non necessari. (Il telaio in legno, i chiodi, i cartoni, i sacchetti di plastica e i nastri isolanti potrebbero provocare lesioni. Inoltre, assicurarsi che i bambini non giochino con i materiali per imballaggi, in quanto potrebbero essere causa di soffocamento o altri infortuni.) • Installare la vasca da bagno in modo sicuro e in posizione stabile, in un luogo con caratteristiche atte a sorreggerne il peso, attenendosi alle istruzioni del Manuale di installazione. • Si raccomanda di assumere posizioni ergonomiche durante il trasporto e il montaggio. (Accertarsi che tutte le operazioni vengano eseguite in sicurezza. Si raccomanda di farsi aiutare da qualcuno, onde evitare il rischio di incidenti o infortuni.) • Durante l'installazione, osservare le norme antinfortunistiche e i regolamenti edilizi locali, nonché tutte le norme igieniche e ambientali.

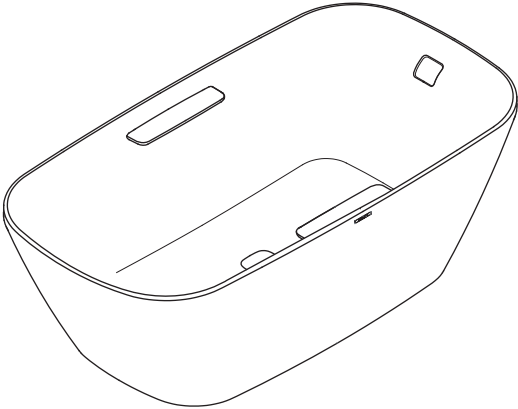
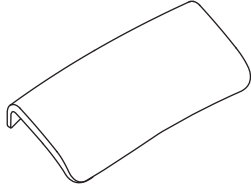
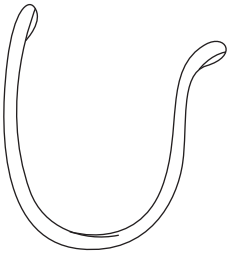
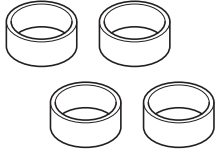
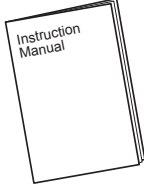

ATTENZIONE

 Vietato	<ul style="list-style-type: none"> • Non appoggiare oggetti pesanti sulla vasca e non collocare al suo interno oggetti su cui salire in piedi. (Diversamente si potrebbero provocare danni).
	<ul style="list-style-type: none"> • Non far cadere oggetti duri o pesanti nella vasca da bagno e non giocare dentro alla vasca. (Le eventuali fessurazioni della vasca da bagno potrebbero essere causa di infortuni e, in caso di perdite, si potrebbero sporcare o danneggiare oggetti o parti dell'edificio.)
	<ul style="list-style-type: none"> • Le fonti di calore devono essere mantenute a debita distanza. Non fumare. (In caso di mancata osservanza di questa precauzione si potrebbero verificare danni.)
	<ul style="list-style-type: none"> • Non installare la vasca da bagno all'aperto o in luoghi in cui sia costantemente esposta alla luce solare (ad esempio in un solarium). (In caso di mancata osservanza di questa precauzione, la vasca potrebbe essere danneggiata dal gelo, oppure potrebbe scolorirsi.)
	<ul style="list-style-type: none"> • Durante il trasporto, non sorreggere la vasca afferrando i tubi flessibili o le tubazioni, e fare attenzione a non urtarla con oggetti duri.
 Obbligatorio	<ul style="list-style-type: none"> • Prima di procedere all'installazione, controllare la vasca e le tubazioni per evidenziare eventuali danni o anomalie. (Non montare componenti danneggiati o che presentano anomalie. Richiedere dei pezzi di ricambio.)
	<ul style="list-style-type: none"> • Non asportare la pellicola protettiva dalla vasca fino a quando l'installazione non sarà completata.
	<ul style="list-style-type: none"> • Assicurarsi che la vasca da bagno possa essere utilizzata e sottoposta a manutenzione in modo idoneo.
	<ul style="list-style-type: none"> • Al termine dell'installazione, controllare che non vi siano perdite. (Se si riscontrano perdite, arrestare l'erogazione dell'acqua e riparare immediatamente.)

Included parts / Mitgelieferte Teile / Pièces fournies / Parti in dotazione

<p>A-1</p> 	<p>A-2</p> 		
<p>A-4</p> 	<p>A-3</p> 		
<p>A-5</p> 	<p>Instruction Manual Bedienungsanleitung Manuel d'instructions Manuale di istruzioni</p>	<p>A-6</p> 	<p>Installation Guide Installationsanleitung Guide d'installation Manuale di installazione</p>

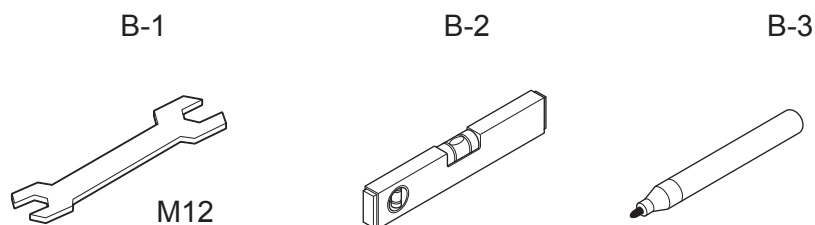
Required tools / Erforderliches Werkzeug / Outils requis / Utensili richiesti



Specifications / Spezifikationen / Caractéristiques / Specifiche tecniche

GB

Item	Name	Specification
Bathtub	Dimensions	1,800 × 950 × 600 mm
	Inner dimensions	Length 1,580 mm, width 850 mm
	Bathtub depth	445 mm
	Capacity	306 l
	Weight	134 kg
	Material	FRP
	Drainage method	Normal drainage and overflow
	Drain plug	Press type drain
	Drainage rate (with trap)	0.6 l/sec
Overflow rate	0.7 l/sec	

DE

Gegenstand	Bezeichnung	Spezifikation
Badewanne	Abmessungen (außen)	1.800 × 950 × 600 mm
	Abmessungen (innen)	Länge 1.580 mm, Breite 850 mm
	Badewannenhöhe	445 mm
	Kapazität	306 l
	Gewicht	134 kg
	Material	FRP
	Art des Abflusses	Herkömmlicher Abfluss und Überlauf
	Stöpsel	Drücken drain
	Abflussgeschwindigkeit (mit Siphon)	0,6 l/sec
Überlaufgeschwindigkeit	0,7 l/sec	

FR

Élément	Nom	Spécifications
Baignoire	Dimensions de la baignoire	1 800 × 950 × 600 mm
	Dimension intérieures	Longueur 1 580 mm, largeur 850 mm
	Profondeur de la baignoire	445 mm
	Capacité	306 l
	Poids	134 kg
	Matière	FRP
	Méthode de vidange	Vidange normale et trop-plein
	Bouchon de vidange	Type de presse vidange
	Débit de vidange (avec siphon)	0,6 l/sec
Débit du trop-plein	0,7 l/sec	

IT

Voce	Denominazione	Specifiche
Vasca	Vasca da bagno Dimensioni	1.800 × 950 × 600 mm
	Dimensioni interne	Lunghezza 1.580 mm, larghezza 850 mm
	Profondità della vasca	445 mm
	Capacità	306 l
	Peso	134 kg
	Materiale	FRP
	Metodo di scarico	Scarico normale e troppopieno
	Piletta di scarico	Tipo Press scarico
	Velocità di deflusso (con sifone)	0,6 l/sec
Velocità di deflusso troppopieno	0,7 l/sec	

Dimension Drawings / Abmessungen / Schémas des dimensions / Schemi dimensionali

- Bathtub
- Badewanne
- Baignoire
- Vasca

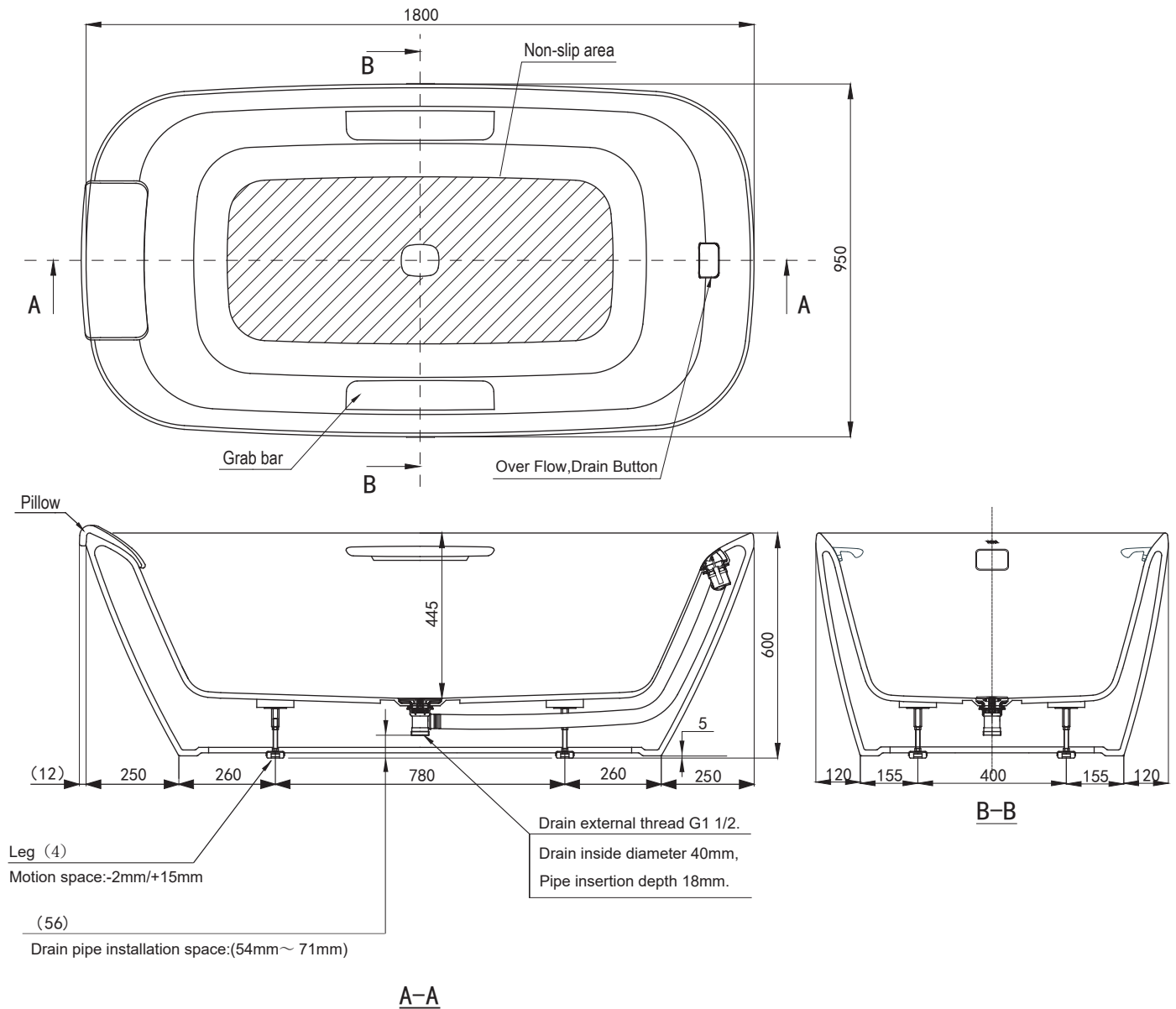

Nota.: "H" in codice prodotto indica che vasca è dotata di maniglione.

Installation Procedure
Installation
Procédure d'installation
Procedura di installazione

Building a base for the bathtub
~ seating the bathtub
Schaffen einer Bodenfläche für die
Badewanne ~ Aufstellen der Badewanne
Fabrication d'une base pour la baignoire
~ installation de la baignoire
Realizzazione di una base in muratura per la
vasca da bagno ~ posa della vasca da bagno

- ▶ See page 14.
- ▶ Vgl. S. 14.
- ▶ Voir page 14.
- ▶ Vedere a pagina 14.



Finishing
Fertigstellung
Finition
Operazioni finali

- ▶ See page 16.
- ▶ Vgl. S. 16.
- ▶ Voir page 16.
- ▶ Vedere a pagina 16.



Pillow
Kissen
Oreiller
Cuscino

- ▶ See page 18.
- ▶ Vgl. S. 18.
- ▶ Voir page 18.
- ▶ Vedere a pagina 18.

Meaning of the indications
Bedeutung der Hinweise
Signification des indications
Significato delle indicazioni

GB



: Task that must be conducted by the installer



: Action that the BATHTUB should perform automatically



: Work that requires confirmation



: Shows the work sequence

DE



: Diese Aufgabe ist vom Installateur auszuführen



: Diese Funktion wird vom BATHTUB automatisch ausgeführt



: Bei dieser Tätigkeit ist eine Bestätigung erforderlich



: Zeigt den Arbeitsablauf an

FR



: Tâche incombant à l'installateur



: Action que le BATHTUB doit exécuter automatiquement



: Tâche exigeant une vérification



: Indique l'ordre de suivi de la procédure

IT



: operazione che deve essere eseguita dall'installatore



: operazione che il BATHTUB dovrebbe eseguire automaticamente



: intervento che deve essere preceduto da verifiche



: indica la sequenza di lavoro

Building a base for the bathtub ~ seating the bathtub
Schaffen einer Bodenfläche für die Badewanne ~ Aufstellen der Badewanne
Fabrication d'une base pour la baignoire ~ installation de la baignoire
Realizzazione di una base in muratura per la vasca da bagno ~ posa della vasca da bagno

1

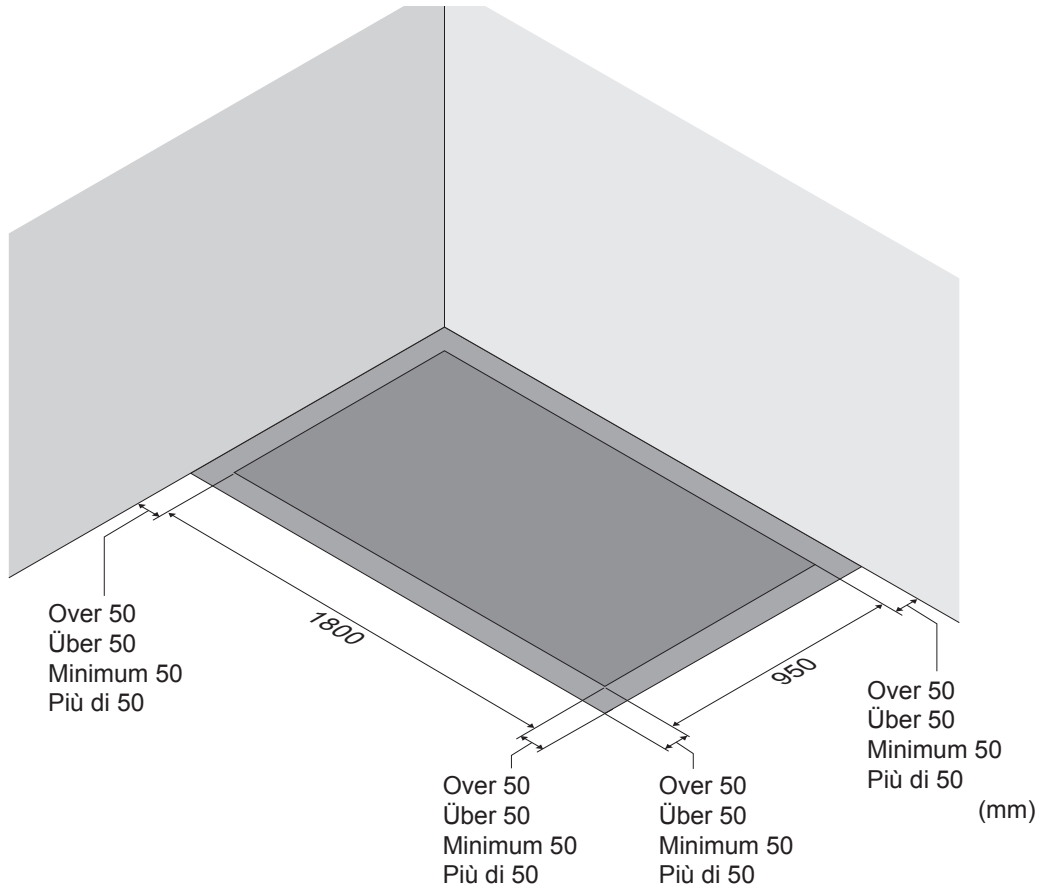

2

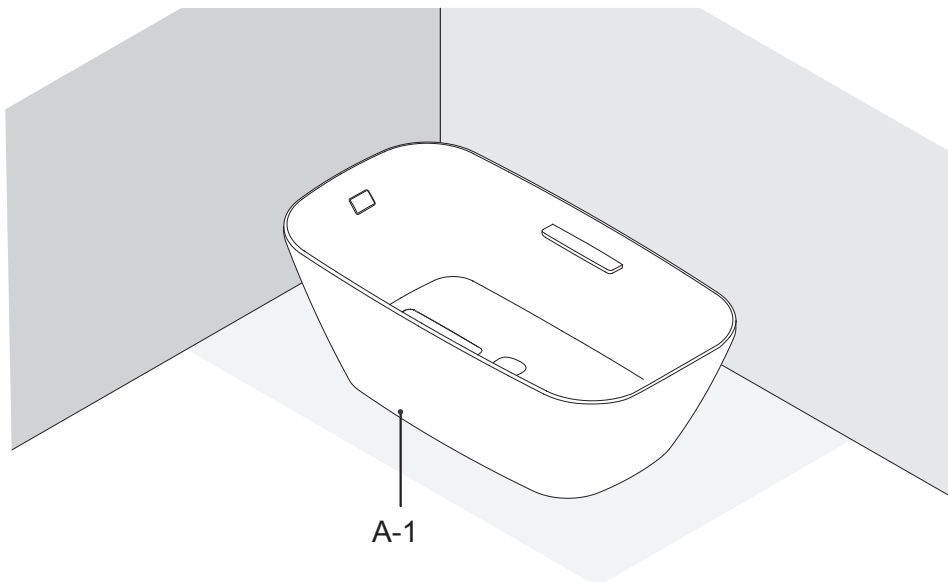

3

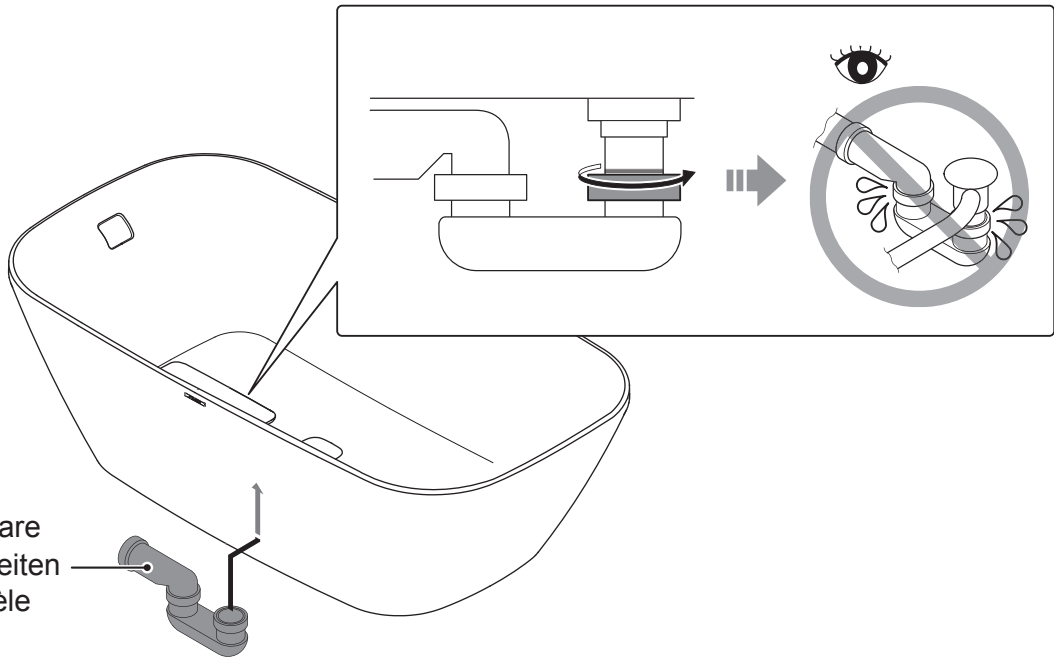

4

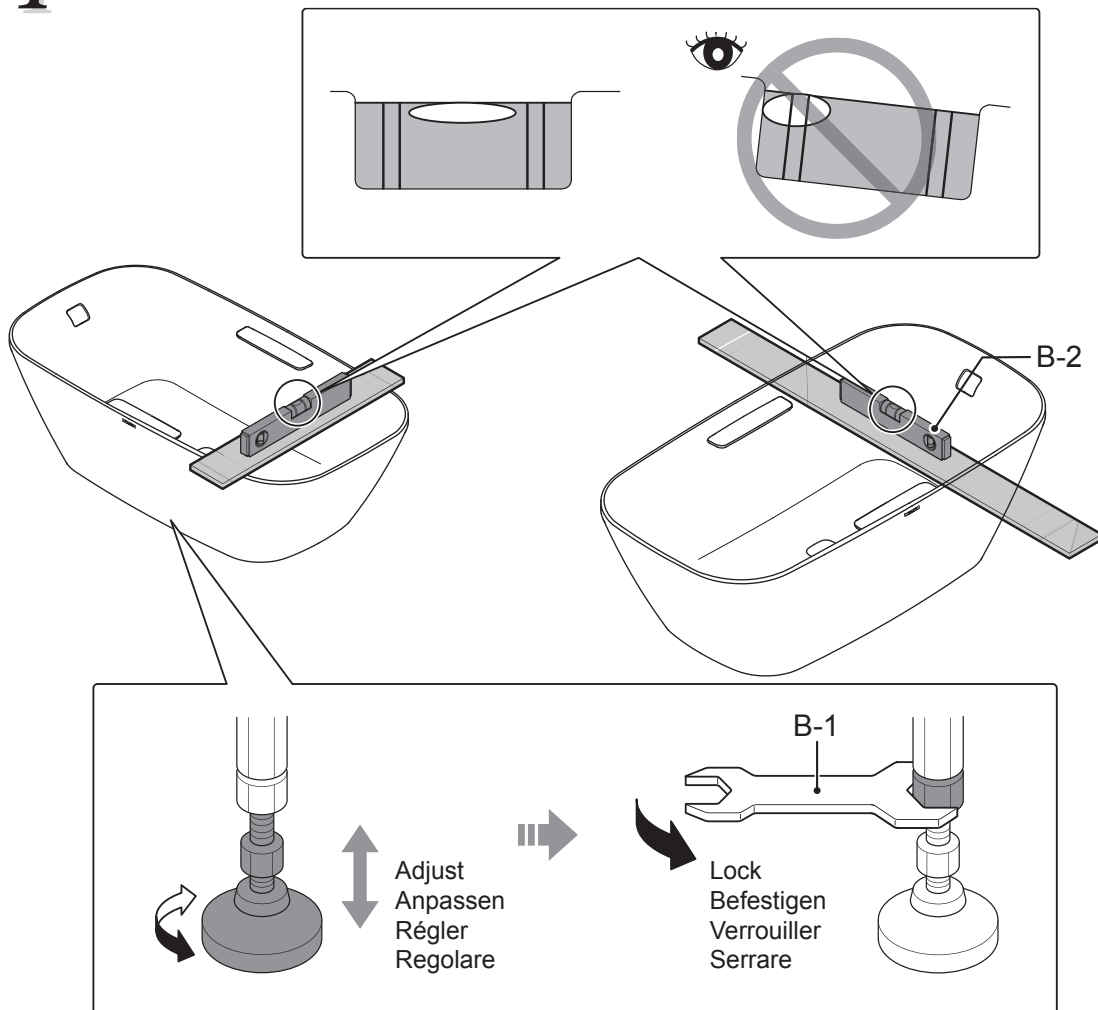

Finishing / Fertigstellung / Finition / Operazioni finali

1

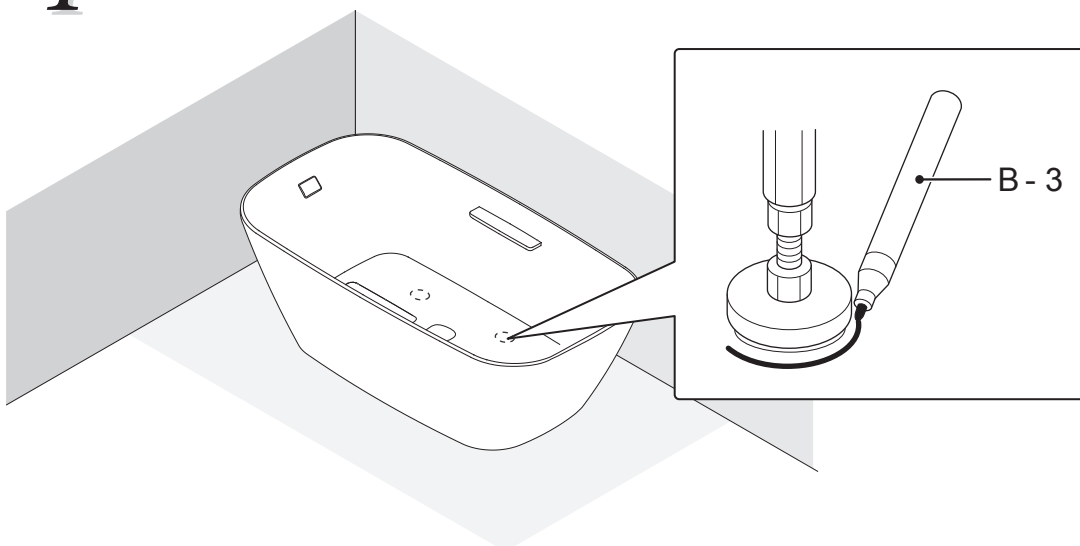

2

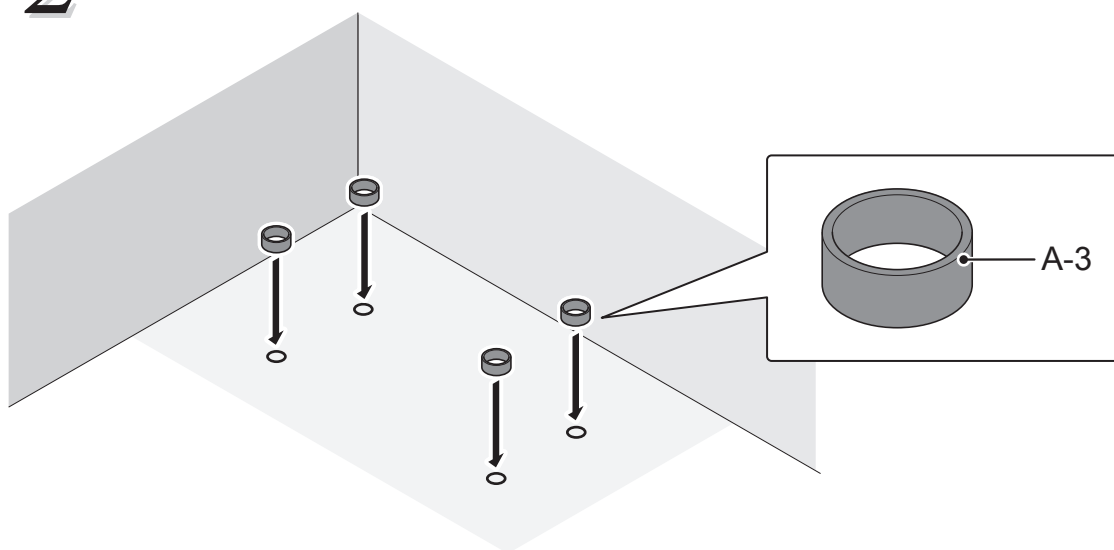

4

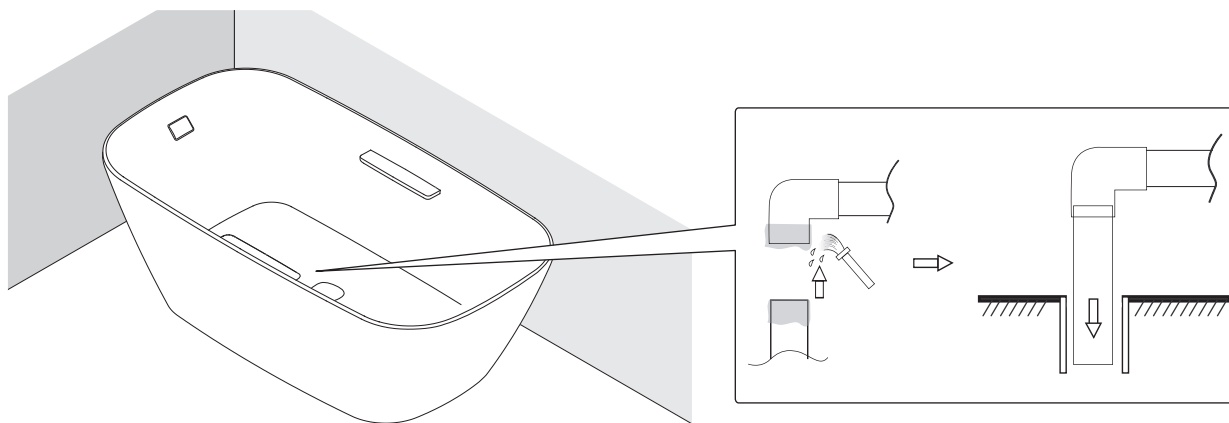



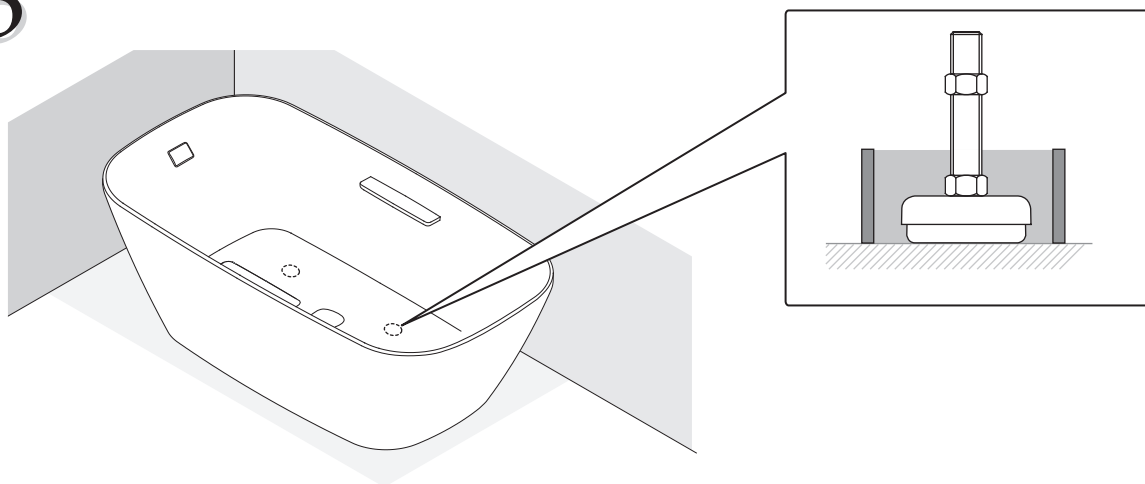



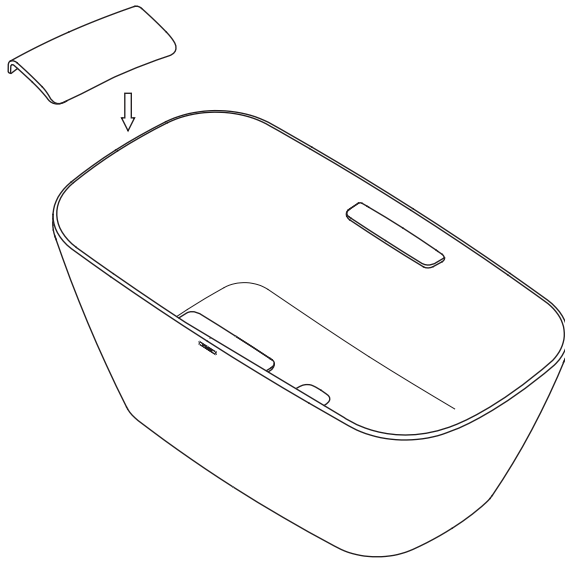

5



[GB] ⚠ CAUTION	
! Required	Fix the bathtub in place with mortar according to the provided parts (A-3).
[DE] ⚠ VORSICHT	
! Erforderlich	Verankern Sie die Badewanne mit Mörtel gemäß den mitgelieferten Anweisungen (A-3).
[FR] ⚠ MISE EN GARDE	
! Requis	Fixez la baignoire avec du mortier en utilisant les pièces fournies (A-3).
[IT] ⚠ ATTENZIONE	
! Obbligatorio	La vasca deve essere fissata con malta utilizzando i componenti forniti (A-3).

Pillow / Kissen/Oreiller / Cuscino



[GB]  CAUTION	
 Required	Pillow must be mounted on the opposite side of the drain button.(A-2)
[DE]  VORSICHT	
 Erforderlich	Kissen muss auf der entgegengesetzten Seite der Drain-Taste befestigt werden.(A-2)
[FR]  MISE EN GARDE	
 Requis	Oreiller doit être monté sur le côté opposé de la touche de vidange.(A-2)
[IT]  ATTENZIONE	
 Obbligatorio	Cuscino deve essere montato sul lato opposto del pulsante di scarico.(A-2)

©TOTO Ltd. All rights reserved.
©TOTO Ltd. Alle Rechte vorbehalten.
©TOTO Ltd. Tous droits réservés.
©TOTO Ltd. Tutti i diritti riservati.

Printed in China.
Gedruckt in China.
Imprimé au China.
Stampato in Giappone.